



January  
2024

Healthcare Parts &  
Accessories

## Wheelchair Parts

**COMPARE & SAVE**

Offering the Lowest Pricing Around with Wholesale Pricing

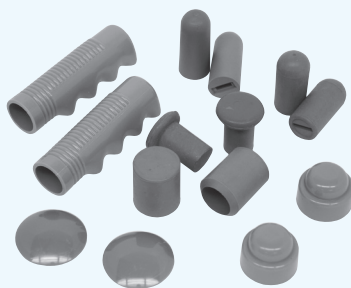

Shop Online - [www.ocelco.com](http://www.ocelco.com)



Or Call 1-800-328-5343

**Office Hours: Monday thru Friday 7:00 am to 4:30 pm (CST)**

## Table of Contents

Accessories   46-49	Knee Scooters / Walkers   61
Adaptive Positioners   49-57	Legrest Release Levers   37
Armrests   11-13	Medical Equipment   66
Axles, Bolts, & Nuts   26-27	Pads & Cushions   52-57
Bearings   1-7	Pads, Cushions, & Trays   51
Brakes   22-24	Pill Management   68
Calf Pads   38	PVC Shower/Commode Chairs   58
Cushions   51-55	Quickie Upholstery   20
Custom Upholstery   14	Safety Belts   67
E&J Upholstery   16-17	Seat Rail Guides & Button Locks   9
Foot and Legrest Parts   39-40	Skirt Guards   10-11
Foot and Legrests   41-45	Snap-On-Tires   28
Forks & Spacers   36	Spacers / Screws / Clips   25
Front Rigging   43-47	Tire Tools   27
Grips & Caps   8	Tires, Tubes, & Inserts   29-33
Handrim Parts   27	Trays   67
Hoyer Lifts & Parts   62-65	Upholstery   14-21
Invacare Upholstery   18-19	Upholstery Sets   21
	Wheelchairs   60
	Wheels   32-35
	Wheels, Forks, & Spacers   21

## Company Policy

**ATTENTION:** You'll get attentive, informed, person to person service whether you're placing an order or making an inquiry. Our customer service representatives will serve you promptly, efficiently and courteously. We stand firmly behind the Ocelco name.

**TERMS:** Our terms are **NET 45 DAYS, 2% discount if paid within 30 days** (excluding Credit Card payments & freight is NOT discountable) on all new and current accounts. Payment In Advance if not current. Payments become due 45 days after the invoice date, if the order is complete or not. Shipments will be held if an account contains invoices over 45 days past due. The account will go on permanent Payment In Advance when there is a history of past dues. All items sold on open accounts are secured items until paid in full. Third party collection fees and legal fees must be paid in full before an account can be reopened.

\$30.00 NSF Fee will be charged on all returned checks

**FREIGHT:** Freight will be prepaid and added to your invoice. Freight charges are part of your invoice and are due accordingly. Freight charges are not discountable.

**PROOF OF DELIVERY:** Ocelco will provide proof of delivery at your request. The fee for proof of delivery is \$15 if the customer received the package, no charge if it was lost in delivery. Be absolutely sure you did not receive the package before calling for proof of delivery.

**PRICES:** All prices are subject to change without notice. Prices reflect single unit cost, except where noted, no quantity discounts allowed. In the past, 95% of our prices remained in effect for more than one year. However, there may be price changes in accordance with our suppliers.

**MINIMUM ORDER:** No Order is too small.

**RETURNS:** No item will be accepted for return after 15 days from date of purchase. All returns must be labeled with a return authorization number which can be obtained from our customer service department. Claims for shortage, breakage or any other reason must be made within 48 hours of receipt. Shipping containers must be kept if shipment is damaged or short. All returns are subject up to a **35% restocking fee**. The customer is responsible for all freight charges incurred.

**CANCELLATION CHARGES:** Orders may be canceled without charge providing your request is received prior to shipment. If the merchandise has been shipped there will be up to **35% restocking fee**, plus all freight charges incurred. Please get cancellation conformation to avoid these charges.

**OTHER ORDER INFORMATION:** We reserve the right to split shipments. We sell on first come first serve basis. Where available, substitutions will be shipped if the product ordered is not available or discontinued.

**We accept:**



**and Purchase Orders**

**Tel:** 1-800-328-5343 **Fax:** 1-866-829-9744

## Old Style Everest & Jennings Bearings

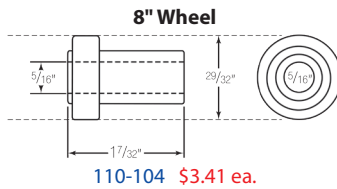
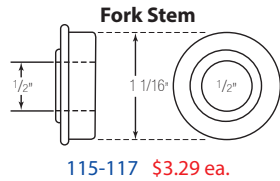
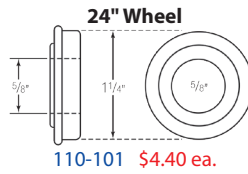
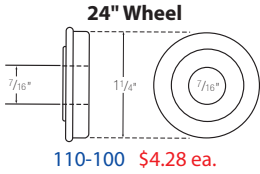

### Bearing Sets

**Bearing set for chair with 7/16" axle on 24" wheel**  
2 ea. 110-100 24" Wheel  
2 ea. 110-104 8" Wheel  
2 ea. 115-117 Fork Stem  
118-100 \$20.05 set

**Bearing set for chair with 5/8" axle on 24" wheel**  
2 ea. 110-101 24" Wheel  
2 ea. 115-117 Fork Stem  
118-101 \$23.39 set

## Invacare Bearings

### Bearing Sets

**Bearing set for chair with 5/8" axle on 24" wheel**  
2 ea. 110-103 24" Wheel  
2 ea. 115-113 8" Wheel  
2 ea. 115-109 Fork Stem  
118-103 \$24.36 set

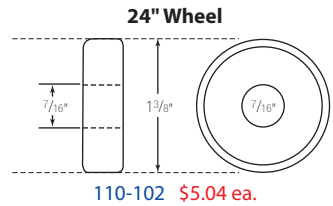
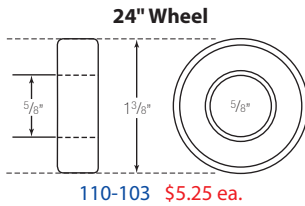

**Bearing set for chair with 7/16" axle on 24" wheel**  
2 ea. 110-102 24" Wheel  
2 ea. 115-113 8" Wheel  
2 ea. 115-109 Fork Stem  
118-102 \$24.36 set

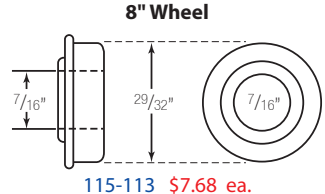
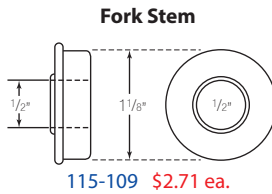

## Theradyne Bearings

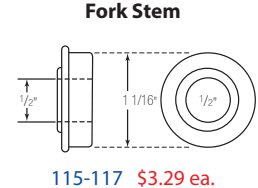
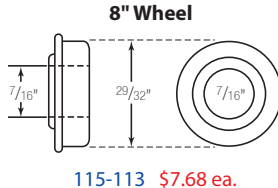
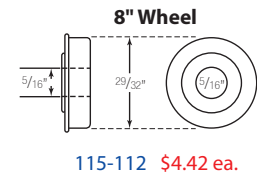
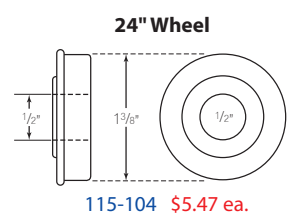
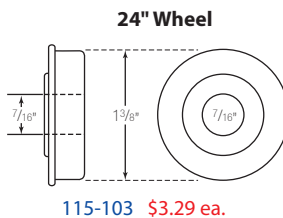
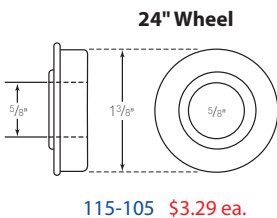

### Bearing Sets

**Bearing set for chair with 1/2" axle on 24" wheel**  
2 ea. 115-104 24" Wheel  
2 ea. 115-113 8" Wheel  
2 ea. 115-117 Fork Stem  
118-106 \$26.80 set

**Bearing set for chair with 5/8" axle on 24" wheel**  
2 ea. 115-105 24" Wheel  
2 ea. 115-113 8" Wheel  
2 ea. 115-117 Fork Stem  
118-105 \$23.29 set

**Bearing set for chair with 7/16" axle on 24" wheel**  
2 ea. 115-103 24" Wheel  
2 ea. 115-113 8" Wheel  
2 ea. 115-117 Fork Stem  
118-104 \$23.66 set

# Metric/Medline Bearings

**Medline, Drive**  
**8" Wheel - 8mm x 22mm**

**Set includes 2 bearings and 1 bushing.**

**Sealed outside**

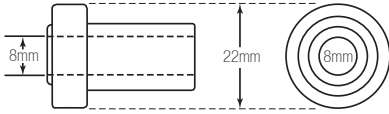

112-112 w/bushing \$29.67 set

**Medline, New Everest & Jennings**  
**8" Wheel 8mm x 22mm**

**Precision Sealed outside & inside**

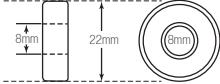

112-102 w/o bushing \$3.66 ea.

**Medline 24" Wheel without flange**  
**12mm x 37mm**

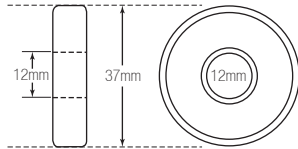

**Precision Sealed outside & inside**

112-110 12mm \$4.40 ea.

112-111 15mm \$19.27 ea.

**Drive Fork Stem**  
**13mm x 28mm**

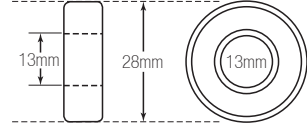

112-114 w/o flange \$3.83 ea.

112-113 with flange \$20.12 ea.

**Drive Wheel Bearing without flange**  
**11mm x 23mm Cruiser III**

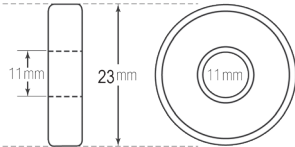

112-115 \$21.34 ea.

## Quickie Bearings

**8" Wheel**

**Precision Sealed outside & inside**

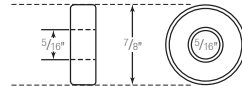

**5/16" x 7/8"**

112-102 \$3.66 ea.

**Drive 24" Wheel without flange**  
**11mm x 35mm Cruiser and Silver Sport**

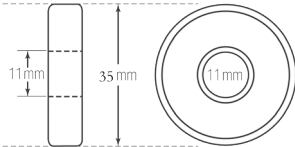

112-106 \$21.33 ea.

**Fork Stem & 24" Wheel**  
**Precision Sealed outside & inside**

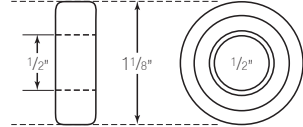

**1/2" x 1-1/8"**

115-110 \$4.69 ea.

**Medline, Drive & New Everest & Jennings**  
**Fork Stem**  
**12mm x 28mm**

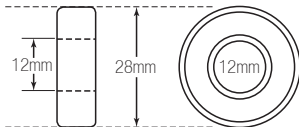

**Precision Sealed outside & inside**

112-101 w/o flange \$4.40 ea.

112-104 with flange \$13.37 ea.

**Theradyne &**  
**Everest & Jennings Fork Stem**

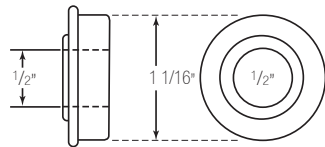

**1/2" x 1-1/16" with 1-3/16" flange**

115-117 \$3.29 ea.

**12mm x 32mm**  
**Precision Sealed outside & inside**

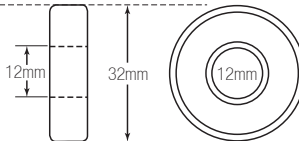

112-100 w/o flange \$4.40 ea.

112-103 with flange \$12.62 ea.

**Colson 8" Wheel, Invacare Fork Stem,**  
**and some Gendron Fork Stems**

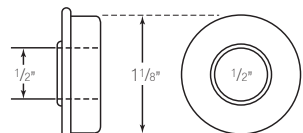

**1/2" x 1-1/8" with a 1-1/4" flange**

115-109 \$2.71 ea.

**Theradyne, Invacare & some Gendron  
8" Wheel**

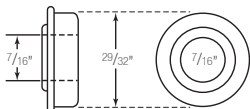

**7/16" x 29/32" with a 1-1/16" flange**

115-113 Deluxe \$7.68 ea.

115-130 Econo \$2.24 ea.

**Invacare 24" Wheel**

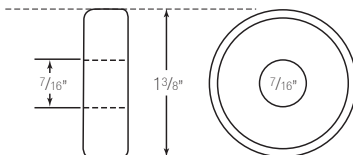

**7/16" x 1-3/8"**

110-102 \$5.04 ea.

**Theradyne 8" Wheel**

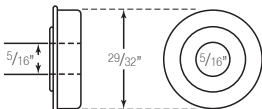

**5/16" x 29/32" with 1" flange**

115-112 \$4.42 ea.

**Old Everest & Jennings 8" Wheel**

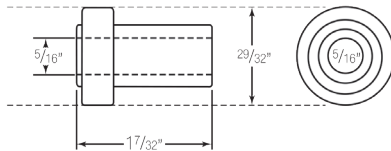

**5/16" x 29/32"**

110-104 \$3.41 ea.

**Theradyne & some Gendron  
24" Wheel**

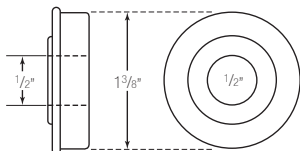

**1/2" x 1-3/8" with 1-1/2" flange**

115-104 \$5.47 ea.

**Old Everest & Jennings 24" Wheel**

**Precision Sealed.**

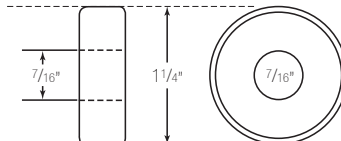

**7/16" x 1-1/4" with out flange**

110-106 Disc.

**Theradyne 24" Wheel**

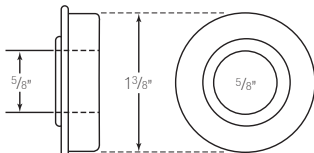

**5/8" x 1-3/8" with 1-1/2" flange**

115-105 \$3.29 ea.

**Everest & Jennings 24" Wheel**

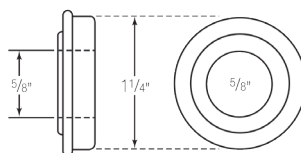

**5/8" x 1-1/4" with a 1-3/8" flange**

110-101 \$4.40 ea.

**Theradyne 24" Wheel**

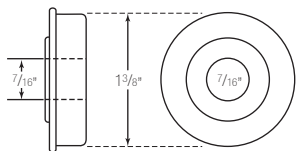

**7/16" x 1-3/8" with 1-1/2" flange**

115-103 \$3.29 ea.

**Everest & Jennings 24" Wheel**

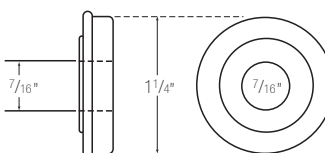

**7/16" x 1-1/4" with a 1-3/8" flange**

110-100 \$4.28 ea.

**Invacare 24" Wheel**

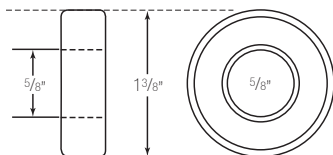

**5/8" x 1-3/8"**

110-103 \$5.25 ea.

**7/16" x 7/8"**

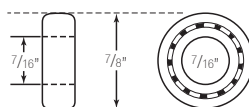

115-121 \$9.44 ea.

**1/4" x 29/32" with a 1" flange**

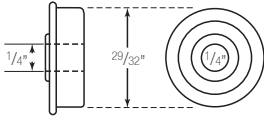

115-115 Disc.

**5/8" x 1-1/8"**

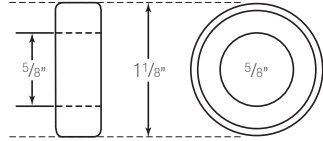

115-111 \$9.61 ea.

**7/16" x 29/32"**

**Precision Sealed**

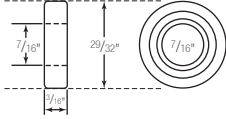

115-114 3/16" Thick, std \$3.29 ea.  
115-125 5/16" Thick \$3.29 ea.

**1/2" x 1-1/4" with a 1-3/8" flange**

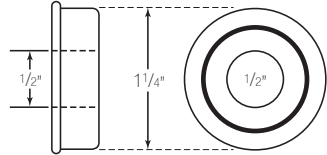

115-101 \$11.02 ea.

**1/2" x 1"**

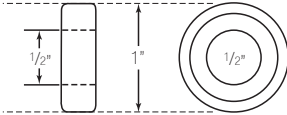

115-116 \$4.36 ea.

**5/8" x 1-1/4" with a 1-11/32" flange**

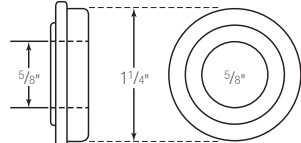

115-102 \$10.61 ea.

**7/16" x 1-1/16" with 1-3/16" flange**

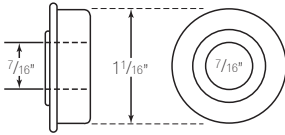

115-119 \$4.98 ea.

**1/2" x 1-3/8"**

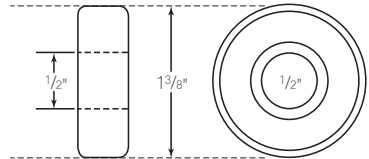

110-105 \$5.51 ea.

**Plastic Bearing (Not MRI Safe)**

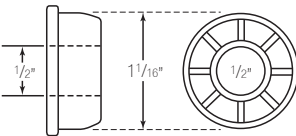

**1/2" x 1-1/16" with 1-3/16" flange**

115-118 \$22.09 ea.

**5/8" x 1-1/2" with a 1-5/8" flange**

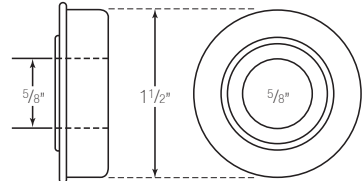

115-122 \$9.27 ea.

**7/16" x 1-1/8"**

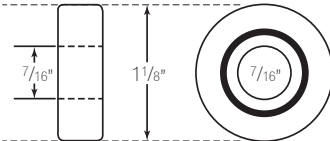

115-108 \$3.98 ea.

**7/16" x 1-1/8" with a 1-1/4" flange**

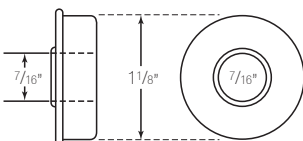

115-107 \$3.19 ea.

**1" x 2"**

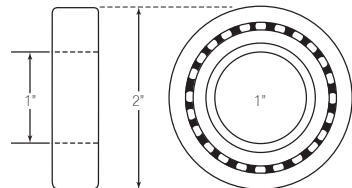

115-123 \$9.97 ea.

## Bearing Cone

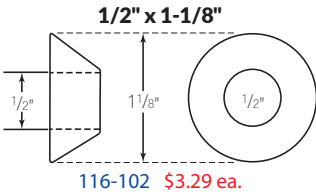
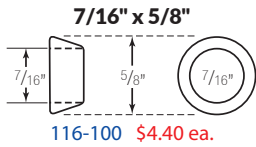

### Invacare 24" Wheel & Fork Stem

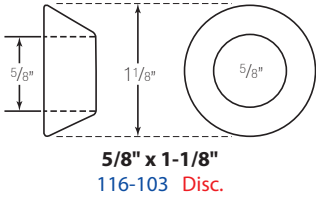

### Invacare 24" Wheel & Fork Stem

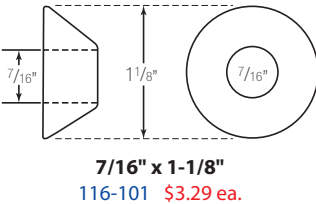

**Felt Washer 5/8" I.D.**  
117-100 \$4.17 ea.

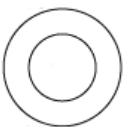

**Nylon White Washer**  
117-110 \$.80 ea.

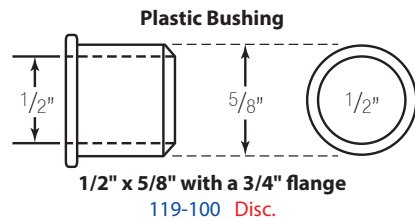

### Invacare Fork Stem

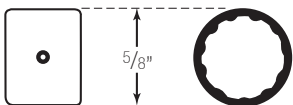

**Needle Bearing**  
113-100 \$7.15 ea.

## Ball Bearings



**Invacare Fork Stem**  
5/8" I.D.  
111-100 \$3.29 ea.



**1-1/8" I.D.**  
111-103 Disc.



**Invacare Fork Stem**  
7/8" I.D.  
111-101 Disc.



**Invacare 24" Wheel**  
1" I.D.  
111-102 \$1.46 ea.

## Thrust Washers

### Invacare Fork Stem

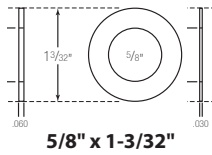

117-101 .060 thick \$1.27 ea.  
117-102 .030 thick \$1.33 ea.

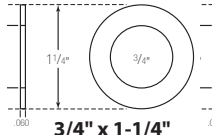

117-103 .060 thick \$1.33 ea.  
117-104 .030 thick \$1.33 ea.

## Thrust Bearings

### Invacare Fork Stem

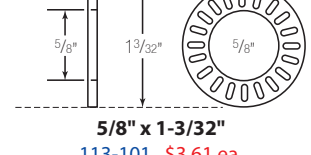

113-101 \$3.61 ea.

### Invacare Fork Stem

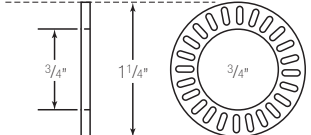

113-102 \$4.11 ea.

## Plastic Bearings used on MRI Wheelchairs or Pool Chairs



**MRI 8" x 1" Front Wheel**  
with 5/16" axle



**MRI Fork/Caster Stem**  
with 1 1/2" Flange  
1/2" ID x 1 1/16" OD  
115-128 \$22.09 ea.

**18" to 24" Chair**  
5/16" ID x 29/32" OD  
115-129 \$22.09 ea.

**MRI 8" x 2" Front Wheel**  
**24" to 26" Heavy Duty Chair**  
5/16" ID x 7/8" OD  
115-131 \$22.09 ea.



**MRI Rear Wheel**  
with 1 3/8" Flange  
**18" and 20" Chair**  
7/16" ID x 1 1/4" OD  
115-127 \$22.09 ea.  
**22" and 24" Chair**  
(not 24" HeavyDuty)  
5/8" ID x 1 1/4" OD  
115-126 \$23.43 ea.



**MRI Rear Wheel**  
with 1 1/4" Flange  
and 1 3/8" Flange  
**24" and 26" Wide Heavy Duty Chairs**  
5/8" ID x 1 1/16" OD  
115-106 \$22.09 ea.



**MRI Rear Wheel, Ceramic Ball Bearing**  
with 1 3/8" Flange  
**Heavy Duty Chair**  
5/8" ID x 1 1/4" OD  
115-132 \$76.79 ea.

## Thrust Bearings

### Invacare Fork Stem

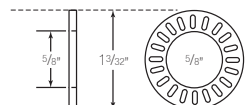

113-101 \$3.61 ea. 113-102 \$4.11 ea.

Visit us online

## Invacare Bearing Housings

114-100 \$7.50 ea.  
 Complete  
 114-201 Disc.

117-105 \$.80 ea.  
 117-106 \$1.72 ea.  
 117-107 \$.80 ea.  
 113-100 \$7.15 ea.

114-101 Disc.  
 114-102 Disc.

Complete  
 114-202 \$20.05 ea.

Complete  
 114-200 \$20.59 ea.

117-101 \$1.27 ea.  
 113-101 \$3.61 ea.  
 117-102 \$1.33 ea.

164-500 \$.25 ea.  
 117-100 \$4.17 ea.  
 114-106 \$12.57 ea.

114-107 Disc.  
 115-105 \$3.29 ea.

Complete  
 114-206 \$27.47 ea.

164-500 \$.25 ea.  
 116-101 \$3.29 ea.  
 111-101 Disc.

Complete  
 114-207 \$41.22 ea.

## Invacare Bearing Housing Theradyne Bearing Housing

164-500 \$.25 ea.  
 117-106 \$1.72 ea.  
 115-114 \$3.29 ea.  
 114-105 \$18.35 ea.  
 119-101 Screw \$.80 ea.  
 111-101 Disc.  
 116-103 Disc.

Complete  
 114-204 Disc.

**Alternate Assembly**

164-500 \$.25 ea.  
 116-100 \$4.40 ea.  
 111-100 \$3.29 ea.

Complete  
 114-200 \$20.59 ea.

164-500 \$.25 ea.  
 117-108 Disc.  
 114-104 \$7.90 ea.  
 Can Be Cut to fit stem.  
 117-109 Disc.  
 119-101 \$.80 ea.  
 115-113 \$7.68 ea.

Complete  
 114-203 Disc.

111-103 Disc.

164-503 \$.89 ea.



## Brake Grips

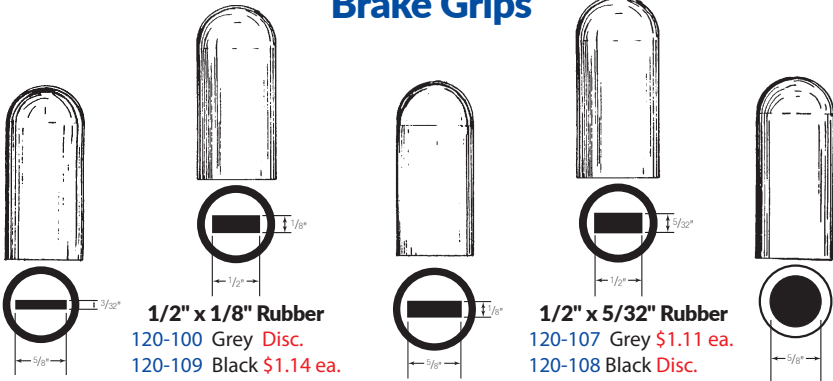

**5/8" x 3/32" Rubber**  
 120-102 Grey \$2.50 ea.  
 120-113 Black \$1.40 ea.

**1/2" x 1/8" Rubber**  
 120-100 Grey Disc.  
 120-109 Black \$1.14 ea.

**5/8" x 1/8" Rubber**  
 120-101 Grey \$1.14 ea.  
 120-110 Black \$1.14 ea.

**1/2" x 5/32" Rubber**  
 120-107 Grey \$1.11 ea.  
 120-108 Black Disc.

**5/8" Dia. Rubber**  
 120-111 Black  
 \$4.95 ea.

## Legrest Grips



**All Drive Wheelchairs  
 Most Medline**  
 120-119 \$4.50 ea.

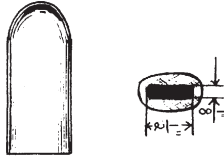

**1/2" x 1/8" Rubber**  
 120-100 Grey Disc.  
 120-109 Black \$1.14 ea.

## Attendant Foot Lift



**Rubber**  
 125-106 Grey Disc.  
 125-107 Black \$2.71 ea.

## Black Plastic Plugs



**5/8"** 124-103 \$1.27 ea.  
**3/4"** 124-104 \$1.33 ea.  
**7/8"** 124-105 \$1.33 ea.  
**1"** 124-107 \$1.33 ea.

## Chrome Claw Plugs



**5/8"** 124-100 \$1.38 ea.  
**3/4"** 124-101 \$1.93 ea.  
**7/8"** 124-102 \$1.64 ea.  
**1"** 124-108 \$1.38 ea.

## Tube Caps

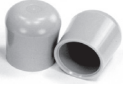

Plastic

125-105 Grey \$1.33 ea.  
 125-102 Black \$0.79 ea.  
 125-100 Brown \$1.33 ea.



Rubber

125-101 Grey Disc.  
 125-104 Black \$1.17 ea.

## Rubber Cap



**Black Rubber Cap for  
 Legrest Release Lever**  
 125-103  
 \$1.98 ea.

## Hand Grips



**Fits over 7/8" O.D. Tubing**  
 121-144 Grey Plastic \$2.07 ea.  
 121-146 Black Plastic \$1.70 ea.



**Fits Most Drive Wheelchairs**  
 121-142  
 Black Plastic  
 \$12.59 pr.

## Wheelchair Grip Sets



### Invacare Grip Sets

128-102 Grey Set Disc.  
 128-103 Black Set \$12.00 set

4 ea. Plastic Tube Cap 7/8"  
 2 ea. Plastic Hand Grip 7/8"  
 2 ea. Plastic Journal Cap 1-1/4" I.D.  
 2 ea. Plastic Hub Cap  
 2 ea. Brake Grip 1/2" x 5/32"  
 2 ea. Brake Grip 1/2" x 1/8"



### Everest & Jennings Grip Sets

128-100 Grey Set Disc.  
 128-101 Black Set \$14.10 set

2 ea. Rubber Tube Cap 7/8"  
 2 ea. Plastic Hand Grip 7/8"  
 2 ea. Plastic Journal Cap 1-13/64" I.D.  
 2 ea. Plastic Hub Cap  
 2 ea. Brake Grip 5/8" x 1/8"  
 2 ea. Brake Grip 1/2" x 1/8"  
 2 ea. Footrest Bumper 3/4"

## Journal Caps

	<b>Black Rubber fits 1" tubing</b>	123-100 Chrome \$1.11 ea.		<b>1-13/64" I.D.</b>	123-104 Chrome Steel \$1.87 ea.
123-106 \$1.83 ea.		123-102 Grey Plastic \$1.77 ea.			123-101 Grey Plastic Disc.
		123-105 Black Plastic \$1.77 ea.			123-103 Black Plastic \$1.25 ea.

## Hub Caps

	<b>Everest &amp; Jennings Plastic</b>	122-100 Grey \$1.75 ea.		<b>Invacare Plastic</b>	122-101 Grey \$1.52 ea.		<b>Drive Black Plastic</b>	122-116 \$20.07 ea.		<b>Hub Cap and Washer</b>	122-102 \$4.44 ea.
122-112 Black \$1.28 ea.		122-109 Black \$1.78 ea.									

	<b>Large Hub Cap Twist-On, Plastic</b>	122-106 Grey \$3.71 ea.		<b>Large Hub Cap Flush Mount, Plastic</b>	122-107 Grey \$3.29 ea.
		122-110 Black \$3.71 ea.			122-111 Black Disc.

## Rail Glides

	<b>Plastic Detach. Arm</b>	126-102 White \$2.68 ea.		<b>Plastic Fixed Arm</b>	126-105 White \$2.63 ea.		<b>Rear Seat Guide Most Drive</b>	126-112 Black \$4.31 ea.		<b>Front Seat Rail Glide - Drive</b>	126-124 Black \$4.64 ea.		<b>Rear Seat Guide - Drive</b>	126-127 Black \$15.80 ea.		<b>Black Coated Steel Fixed Arm</b>	126-106 \$11.00 ea.		<b>Chrome Steel Detach. Arm</b>	126-103 Disc.	<b>Rail Guide Spring</b> 126-104 \$11.00 ea.
--	----------------------------	--------------------------	--	--------------------------	--------------------------	--	-----------------------------------	--------------------------	--	--------------------------------------	--------------------------	--	--------------------------------	---------------------------	--	-------------------------------------	---------------------	---	---------------------------------	---------------	---

## Arm Tube Plugs

	<b>Invacare Arm Tube Plug</b>	109-112 \$8.84 ea.		<b>Invacare Arm Tube Plug</b>	109-110 \$11.00 ea.		<b>Rear Arm Socket Cam Black Steel</b>	126-113 Right \$51.08 ea.	126-114 Left
---	-------------------------------	--------------------	---	-------------------------------	---------------------	---	--	---------------------------	--------------

## Slide Post Glide

	<b>Slide Posts</b>		<b>Slide Post Glide Black Plastic</b>	
---	--------------------	---	---------------------------------------	--

For ordering slide posts & glides call toll free **800-328-5343** with the following information: Make of Chair, Model of Chair, and Serial Number

## Invacare Arm Release Knob



**Fits Most Invacare Chairs**  
109-109 \$9.25 ea.

## Pivot Links

**Black Plastic, fits Drive Cruiser Wheelchairs**

126-140-16	6-1/2" Long for 16" Chair	\$65.06 ea.
126-140-18	7" Long for 18" Chair	\$78.49 ea.
126-140-20	8" Long for 20" Chair	\$78.49 ea.

**Black Plastic**

126-115	Invacare 16" to 18" Chairs	\$13.76 ea.
126-141	Invacare 20" to 22" Chairs	\$13.76 ea.
126-138	Medline Excel K4	\$25.96 ea.



## Button Locks



3/4"  
Long

109-104  
Disc.



109-102  
\$9.76 ea.



109-114  
\$3.98 ea.



109-115  
\$8.07 ea.

For Non Magnetic  
MRI and Pool Chairs



109-113  
\$35.35 ea.



109-111  
\$3.80 ea.



109-103  
Disc.



109-105  
\$1.81 ea.



109-106  
\$8.95 ea.



109-108  
\$11.00 ea.



109-116  
\$21.63 ea.

Drive

## Seat Guides



Invacare Front  
Seat Guide & Arm  
Socket  
Black Plastic  
126-107  
Disc.



Invacare Front  
Seat Guide & Arm  
Socket  
Black Plastic  
126-122  
Disc.



Drive Front Seat  
Guide & Arm  
Socket  
Black Plastic  
126-128  
Disc.



Invacare H-Block  
w/Socket Cup  
Black Plastic  
126-137  
\$15.12 ea.



Invacare  
H-Block Rear  
Seat Guide  
Black Plastic  
126-136  
\$11.00 ea.



Drive Rear  
Seat Guide  
Black Plastic for  
Cirrus III & IV  
126-129  
Disc.



Drive Front  
Seat Saddle  
Black Plastic  
126-131  
\$21.33 ea.

Invacare Rear  
Seat Guide  
Black Plastic  
126-108  
Disc.



Invacare Rear  
Seat Guide  
Black Plastic  
126-123  
\$11.00 ea.



Drive Rear Seat Guide  
Black Plastic for Cirrus III & IV  
126-130  
Disc.

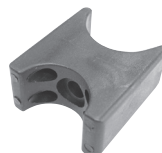

Drive Front Seat Rail Bracket  
for Vipers Black Plastic - New  
Style  
126-134 Right, not shown  
\$21.33 ea.  
126-135 Left, shown  
\$21.46 ea.



Drive Front Seat Rail Bracket for  
Vipers Chrome  
126-132 Right, shown  
\$21.33 ea.  
126-133 Left, not shown  
\$21.33 ea.

### MRI Non-Magnetic Seat Guides



126-150 MRI Seat Guide  
126-151-L MRI Seat Guide  
or  
126-151-R



\$23.45 ea.  
\$26.52 ea.

## Skirtguards

Part #	A	B	Color	Brand	Price
180-107	17-1/4"	6"	Chrome	Most Chairs	\$13.95 ea.
180-109	17-1/4"	6"	Chrome	Gendron	\$19.02 ea.
180-128	8-3/4"	6"	Chrome	Invacare	Disc.
180-129	9-3/4"	6"	Chrome	Invacare	Disc.
180-104	10-1/8"	6"	Chrome	Theradyne	Disc.
180-127	11"	4"	Chrome	Invacare	Disc.
180-132	11-3/8"	6"	Chrome	Theradyne	Disc.
180-111	12-1/4"	6"	Chrome	Invacare	Disc.
180-138	9"	4"	Chrome	Invacare	Disc.
180-123	9-7/8"	6"	Chrome	Invacare	Disc.
180-139	10"	5-1/2"	Chrome	Invacare	\$23.69 ea.
180-121	15-7/8"	6"	Chrome	Invacare	\$13.90 ea.
180-122	10"	6"	Chrome	Everest & Jennings	\$15.12 ea.
180-119	16-3/4"	6"	Chrome	Everest & Jennings	\$14.74 ea.
180-118	9-1/2"	6"	Chrome	Theradyne	Disc.
180-143	12-3/8"	6"	Chrome	Theradyne	Disc.
180-142	18-3/8"	6"	Chrome	Theradyne	Disc.

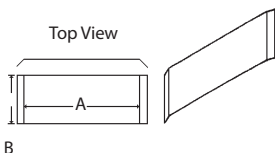
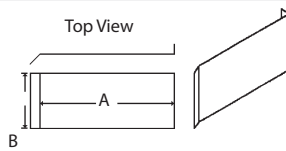
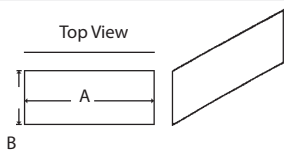
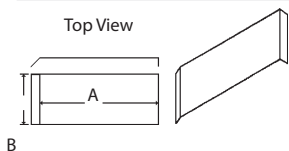

If the part you are looking for is not illustrated or you can not find what you need, let us help!  
**Call toll free 1-800-328-5343**

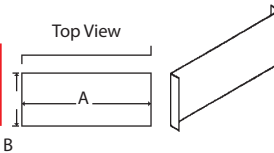

**Invacare Black Steel**  
180-101 \$35.09 ea.



**Invacare Black Steel**  
180-102 \$35.09 ea.



**Invacare Black Plastic-Desk Length**  
180-114 Right \$38.84 ea.  
180-124 Left \$38.84 ea.



**Invacare Black Plastic-Full Length**  
180-148 Right \$38.84 ea.  
180-149 Left \$38.84 ea.



**Invacare Desk Black Plastic**  
181-101 Right \$46.38 ea.  
181-102 Left \$46.38 ea.

### MRI Non-Magnetic Skirtguards



#### MRI Stainless Steel, 6" High, for Removable Arms

180-160 Full, 19 3/8" Long \$53.01 ea.  
180-161 Desk, 13 1/4" Long \$53.01 ea.

#### MRI Non-Magnetic Armrest Assembly

Complete Arm Assembly with Padded Armrest

**Choose Side:** L(left) or R(right)

**Choose Color:** Burgundy (27) or Green (50)



#### Desk Length, Flip-Back, for 18" Wide Chairs

101-400-X-CL \$214.85 ea.

#### Full Length, Detachable Arm Assembly, for 18" to 20" Wide Chairs

101-401-X-CL \$209.31 ea.

#### Desk Length, Detachable Arm Assembly, for 22" to 24" Wide Chairs

101-402-X-CL \$259.70 ea.

#### Desk Length, Detachable Arm Assembly, for 24" to 26" Wide Heavy Duty Chairs

101-403-X-CL \$298.43 ea.

## Detachable Arms

### Standard Detachable Arms

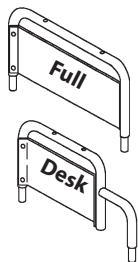

#### Everest & Jennings Arms

- 101-350 Full, L or R \$37.78 ea.  
 102-150 Desk, Lt. \$37.78 ea.  
 102-250 Desk, Rt. \$37.78 ea.

#### Detachable Arms

##### Travler, Traveler Recliner & Traveler XD

- 101-113 Full, R & L Disc.  
 102-113 Desk, R & L Disc.

#### Detachable Arms

##### Vista IC

- 101-114 Full, R & L Disc.  
 102-114 Desk, R & L Disc.

### Adjustable Height Detachable Arms

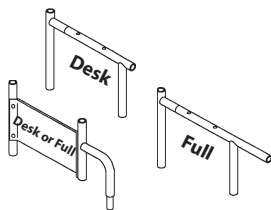

#### Everest & Jennings Arms

- 101-151 Full, Lt. \$55.24 ea.  
 101-251 Full, Rt. \$55.24 ea.  
 102-151 Desk, Lt. \$55.24 ea.  
 102-251 Desk, Rt. \$55.24 ea.

#### Adjustable Height Detachable Arms Traveler, Traveler Recliner & Traveler XD

- 101-153 Full, R & L \$102.15 pr.  
 102-153 Desk, R & L Disc.

#### Adjustable Height Detachable Arms Vista IC

- 102-156 Desk, R & L Disc.

### Wrap Around Detachable Arms

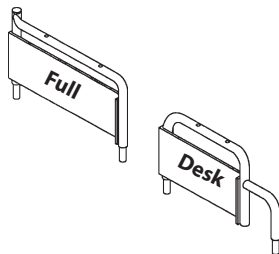

#### Everest & Jennings Arms

- 101-152 Full, Lt. Disc.  
 101-252 Full, Rt. Disc.  
 102-152 Desk, Lt. Disc.  
 102-252 Desk, Rt. Disc.

## Invacare Conventional Arms



**NOTE:** There are many different types of detachable arms, please have the make, model and serial number when ordering detachable arms. We will help you find the arms you need. Call toll free **800-328-5343**.

#### Fixed Height Full Length Arm Assembly

- 1** 101-156-CL Right, Chrome \$104.18 ea.  
 101-256-CL Left, Chrome \$104.18 ea.  
 101-158-CL Right, Black \$112.21 ea.  
 101-258-CL Left, Black \$112.21 ea.  
 101-157-CL Flip Back Right, Black \$102.01 ea.  
 101-257-CL Flip Back Left, Black \$102.01 ea.

#### Fixed Height Desk Length Arm Assembly

- 2** 102-157-CL Right, Chrome \$103.23 ea.  
 102-257-CL Left, Chrome \$103.23 ea.  
 102-159-CL Right, Black \$100.14 ea.  
 102-259-CL Left, Black \$100.14 ea.  
 102-158-CL Flip Back Right, Black \$103.23 ea.  
 102-258-CL Flip Back Left, Black \$103.23 ea.

#### Adjustable Height Full Length Arm Assembly

- 3** 101-154-CL Right, Black \$125.50 ea.  
 101-254-CL Left, Black \$125.50 ea.  
 101-155-CL Right, Chrome Disc.  
 101-255-CL Left, Chrome Disc.

#### Adjustable Height Desk Length Arm Assembly

- 4** 102-154-CL Right, Black \$104.28 ea.  
 102-254-CL Left, Black \$104.28 ea.  
 102-155-CL Right, Chrome \$175.58 ea.  
 102-255-CL Left, Chrome \$175.58 ea.

## Plastic Armrests

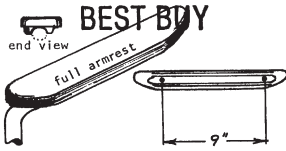

**BEST BUY**  
**Full Length**  
**9" Hole Spacing**  
 Theradyne, E&J  
 170-044 \$4.34 ea.



**BEST BUY**  
**Full Length**  
 Beige  
**10" Hole Spacing**  
 170-096 \$4.34 ea.

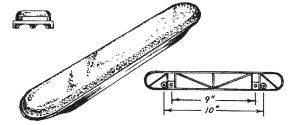

**Full Length**  
 Blue, Grey, Cocoa or Black  
**9" & 10" Hole Spacing**  
 Theradyne, E&J, Invacare,  
 Colson  
 171-0CL \$7.99 ea.

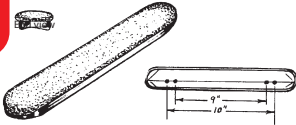

**Full Length**  
 Blue, Beige, Black, or Grey  
 9" & 10" Hole Spacing, 2 piece,  
 Theradyne, E&J, Invacare,  
 Colson  
 171-1CL Disc.

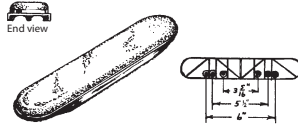

**Desk Length**  
 Blue, Grey, Cocoa, Black  
 3-5/16", 5-1/2" & 6"  
 Hole Spacing  
 Universal  
 172-1CL \$7.92 ea.

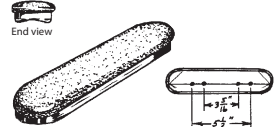

**Desk Length**  
 Blue, Grey, Black or Beige  
 3-5/16" & 5-1/2"  
 Hole Spacing  
 Universal  
 172-2CL \$8.42 ea.

## Padded Armrests

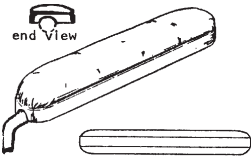

**Full and Desk Length**  
 Colors: Black Only  
 3-1/2" & 6-7/8" Hole Spacing  
 173-346 Full Length \$15.55 ea.  
 174-346 Desk Length \$14.50 ea.

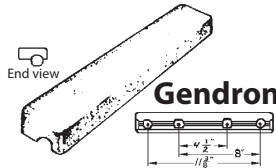

**Full Length**  
 Grey, Black, Brown & Burgundy  
 4-1/2", 8" & 11-3/8" Hole Spacing  
 174-2CL Disc.

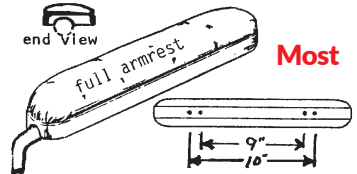

**Full Length**  
 Colors: See Below  
 9" & 10" Hole Spacing  
 Universal, Black Base  
 173-4CL \$10.11 ea.

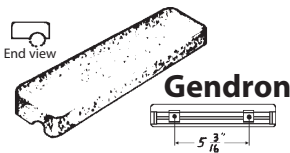

**Desk Length**  
 Grey, Black, Brown &  
 Burgundy  
 5-3/16" Hole Spacing  
 173-1CL Disc.



**Desk Length**  
 Colors: See Below  
 3-5/16" & 5-1/2" Hole Spacing  
 Universal, Black Base  
 174-4CL \$10.11 ea.

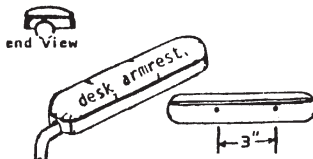

**Desk Length**  
 Colors: Limited please call for availability.  
 3" Hole Spacing  
 Theradyne  
**Limited Quantities and Colors Available**  
 174-1CL Disc.

**Attention !**  
 All Armrests come with attaching hardware. If you would like to purchase extra hardware see the next page for the armrest hardware kits. If you can not find the armrest you are looking for please give us a call toll free **800-328-5343** and we will be happy to assist you.

Colors for Padded Armrests Above: 67 Dark Blue, 68 Royal Blue, 83 Nutmeg, 82 Camel, 23 Mauve, 27 Burgundy, 54 Cactus, 57 Jade, 46 Black or 44 Grey

# MRI Non-Magnetic Armrests Armrest Hardware Kits

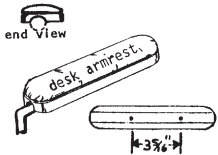

**Desk Length Armrest**  
 Padded with Brass Inserts for MRI Wheelchairs  
 27-Burgundy or 50-Green  
 3-5/16" Hole Spacing  
 179-2CL \$40.39 ea.

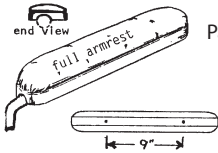

**Full Length Armrest**  
 Padded with Brass Inserts for MRI Wheelchairs  
 27-Burgundy or 50-Green  
 9" Hole Spacing  
 179-1CL \$40.39 ea.



**Armrest Screws  
 Invacare Chairs**

10/32" x 1-1/4" Phillips Pan Head

178-102 \$.26 ea.

**E&J Chairs**

10/32" x 1-1/4" Phillips Oval Head

178-103 \$.26 ea.

**Geri-Chairs**

10/24" x 1-1/4" Phillips Pan Head

178-101 \$.26 ea.



**Hardware Kit  
 Invacare**

50 ea. 178-102  
 178-201 \$7.80 set

**E&J**

50 ea. 178-103  
 178-202 \$8.54 set

**Geri-Chair**

30 ea. 178-101  
 178-200 \$7.80 set

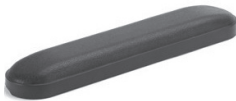

**Full Length Armrest**

13-3/4"  
 Black Only  
 2" | 6-13/16" | 8-15/16" | 10"  
 Hole Spacing  
 175-346 \$15.40 ea.

**Desk Length Armrest**

10-1/4"  
 Black Only  
 3-5/16" | 5-1/2" | 6-15/16"  
 Hole Spacing  
 175-246 \$15.40 ea.

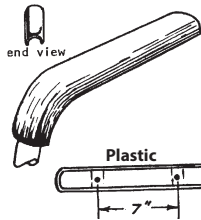

**Full Length Armrest**

Black or White  
 7" Hole Spacing  
 Lumex, Temco Geri-Chair  
 176-0CL \$5.51 ea.

**Large  
 Hardware  
 Kit**  
 50 ea. 178-102  
 50 ea. 178-103  
 20 ea. 178-101  
 178-203  
 \$17.49 set



**Armrest for Lumex**

573/574 Models  
 7-1/2" | 7-15/16" | 7-1/2"  
 Hole Spacing  
 299-901-CL \$27.79 ea.

**Specify color from page 69**



**Armrest/Skirt for Lumex**

565G, 565PG & 565WG Models  
 7" | 7-5/8" | 7"  
 Hole Spacing

307-168 Left \$74.58 ea.  
 307-169 Right \$74.58 ea.

**Specify color from page 69**

**Attention !** All Armrests come with attaching hardware. If you would like to purchase extra hardware see above for the armrest hardware kits. If you can not find the armrest you are looking for please give us a call toll free **800-328-5343** and we will be happy to assist you.

## Arm Trough



Available in two standard lengths  
 Desk Arms 9"x5"x5"  
 Full Arms 12"x5"x5"  
 Special sizes available upon request

**Armrest Pads** \$69.97 ea.  
 Full Arm 194-8CL  
 Desk Arm 194-7CL

**Specify color from page 69**

## Wrap Around Armrest Pads



Made with, 1 1/2" foam, 2" velcro, and ties for attaching to arms. Aids in positioning of the patient.

**Armrest Pads** \$56.65 ea.  
 Full Arm 194-5CL  
 Desk Arm 194-6CL

**Specify color from page 69**

## Upholstery Colors

67 Regal (Dk. Blue)  
 68 Royal Blue (Med. Blue)  
 83 Nutmeg ( Brown Orange)  
 82 Camel (Med. Brown)  
 27 Burgundy (Dk. Red)

96 Beige (Off White)  
 54 Cactus (Med. Green)  
 46 Black  
 48 Black Nylon  
 44 Grey

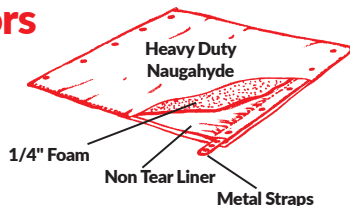

## Custom Size Upholstery Non-Returnable

See Page 69 for Colors

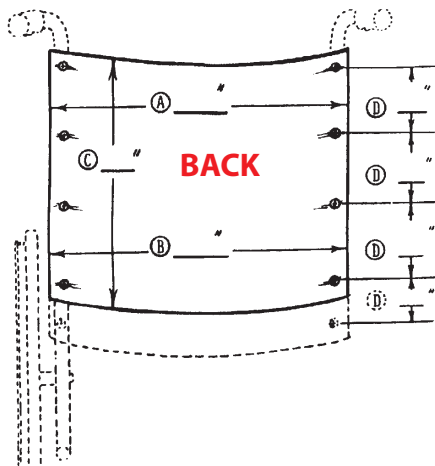

**Custom Back**

1. Fill in all dimensions on drawing
2. Color:
3. Number of Holes:
4. Specify Standard, Pouch or Zipper Back  
(Circle Choice)
5. Brand of Chair:
6. Qty.
7. Fax or call in information  
Fax 218-829-9744  
Toll Free 800-328-5343

Type	Flat (only)
Seat	\$29.95 ea.
Over 22"	\$36.95 ea.
Back	\$29.95 ea.
Over 22"	\$36.95 ea.

Sizes up to 18" x18"  
 Larger sizes may have  
 an up charge.

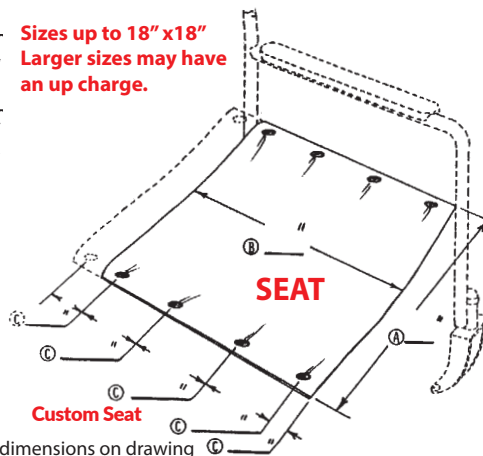

**Custom Seat**

1. Fill in all dimensions on drawing
2. Color:
3. Number of Holes:
4. Brand of Chair:
5. Qty.
6. Fax or call in information  
Fax 218-829-9744  
Toll Free 800-328-5343

**\*\*Visit Our Website [www.ocelco.com](http://www.ocelco.com) For A Fillable Custom Upholstery Form\*\***

**NOTE:** Custom Size Upholstery is not returnable, so please double check your measurements. If you need any help on how to measure your upholstery please call and we will be happy to assist you.



**Can't find what you're looking for?**

**Let us make it for you!**

Ocelco has its own in house Wood Shop and Custom Upholstery Shop. Let us know what you need and we will make it for you. Special size wheelchair upholstery, custom cushions (see page 56-57), adaptive seating, or whatever you may need. Let Ocelco make it to your specifications. We're here to help, please do not hesitate to call us so we can make your special request for you.

Remember "We're The Friendly People"



# Upholstery

## IMPORTANT MEASURING INFORMATION

- 1) Always measure from center of hole to center of hole
- 2) When measuring holes on the back, measure from the top of the back to the bottom of the back.
- 3) When measuring holes on the seat, measure from the front of the seat to the back of the seat.
- 4) When measuring the width of the back upholstery, measure the width at the top of the back and the bottom of the back. Some chairs have backs that flare, smaller at the bottom and larger at the top.

### ADDITIONAL INFORMATION

Please fill in a color code where you see "CL" in the part number.

Color codes can be found in the middle of this page, color swatches may be found inside the back cover. Ocelco Inc. has designed a ruler set **SKU: 510-127** that will help you measure your upholstery quickly and accurately. Our customer service department is ready to help you with your upholstery questions.

**Call us at 1-800-328-5343.**

## Seat Upholstery

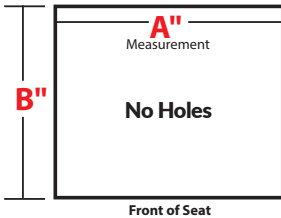

## Pricing

Type	Flat
Seat	\$29.95 ea.
Back	\$29.95 ea.
Type	Embossed
Seat	\$36.95 ea.
Back	\$36.95 ea.

## Back Upholstery

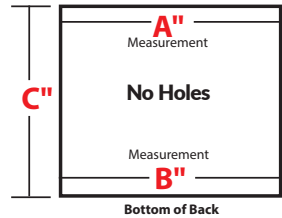

### Seat Upholstery with NO Holes

Part #	A"	B"	Description
137-0CL	16"	16"	Flat Seat Upholstery
186-9CL	16"	16"	Embossed Seat Uph.
137-1CL	18"	16"	Flat Seat Upholstery
137-7CL	18"	16"	Embossed Seat Uph.
137-2CL	18"	17"	Flat Seat Upholstery
131-8CL	20"	16"	Flat Seat Upholstery
137-8CL	20"	16"	Embossed Seat Uph.

### Back Upholstery with NO Holes

Part #	A"	B"	C"	Description
136-0CL	16"	16"	18"	Flat Back Upholstery
136-1CL	17"	16"	18"	Flat Back Upholstery
136-2CL	18"	16"	18"	Flat Back Upholstery
136-3CL	18"	18"	18"	Flat Back Upholstery
137-3CL	18"	18"	18"	Embossed Back Uph
136-4CL	19"	18"	18"	Flat Back Upholstery
137-4CL	19"	18"	18"	Embossed Back Uph
136-5CL	20"	18"	18"	Flat Back Upholstery
137-5CL	20"	18"	18"	Embossed Back Uph
136-6CL	20"	20"	18"	Flat Back Upholstery
136-7CL	21"	20"	18"	Flat Back Upholstery
136-8CL	18"	18"	24"	Flat Back Upholstery

## Upholstery Attaching Hardware



**Uph. Bolt**  
138-101  
\$.36 ea.



**Uph. Screw**  
138-100  
\$.36 ea.



**Uph. Grommet**  
138-103  
\$.38 ea.



**Uph. Strip Screw**  
Use when 138-100 has striped out.  
138-104  
\$.36 ea.



**Uph. Nut**  
138-102  
\$.36 ea.

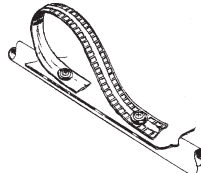

**Closing Strap**  
139-1CL  
\$8.96 ea.

### Uph. Hardware Set

- Set Includes:**
- 50 ea. 138-100
  - 20 ea. 138-101
  - 20 ea. 138-102
  - 100 ea. 138-103
  - 20 ea. 138-104
  - 138-020 \$28.67 set



### Attention !

All Upholstery come with attaching hardware. If you would like to purchase extra hardware some examples of what is available is shown here. If you can not find the upholstery you are looking for please give us a call toll free **800-328-5343** and we will be happy to assist you.

## E&J Style Fits

Everest & Jennings, New Theradyne, C.U.R.E. Galaxy, Hollywood, Tomac, Tuffcare, Smith & Davis, Gemini, Lazer, Hoyer, Lumex

### Back Upholstery

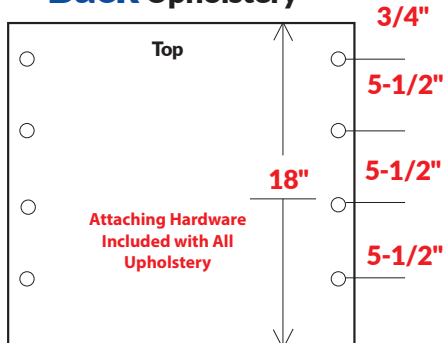

### Seat Upholstery

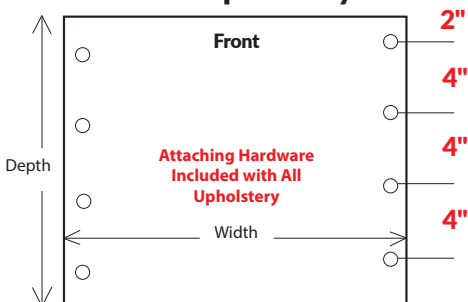

#### Backs

Flat	Embossed	Width
132-1CL	184-1CL	16"
132-2CL	135-5CL	18"
132-7CL	184-2CL	20"
184-3CL	184-4CL	22"
184-5CL	184-6CL	24"

-P Back With Pouch Add (flat only) \$14.00 ea.

-Z Back With Zipper Add (flat only) \$30.00 ea.

#### Seats

Flat	Embossed	Width	Depth
133-1CL	185-2CL	16"	16"
133-2CL	135-6CL	18"	16"
133-3CL	185-3CL	20"	16"
185-4CL	185-5CL	22"	16"
185-6CL	185-7CL	24"	16"
185-8CL	N/A	16"	17"
133-4CL	N/A	18"	17"
186-1CL	N/A	20"	17"
139-8CL	N/A	22"	18"
139-9CL	N/A	24"	18"

#### Upholstery Pricing (16" to 20" Wide)

Type	Flat	Embossed
Seat	\$29.95 ea.	\$36.95 ea.
Back	\$29.95 ea.	\$36.95 ea.

#### Upholstery Pricing (22" to 24" Wide)

Type	Flat	Embossed
Seat	\$36.95 ea.	\$43.95 ea.
Back	\$36.95 ea.	\$43.95 ea.

## E&J Recliner Upholstery

Seats - same as standard E&J Seats

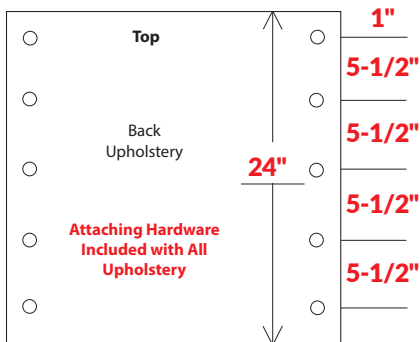

See Page 69 for Colors

### Recliner Headrest

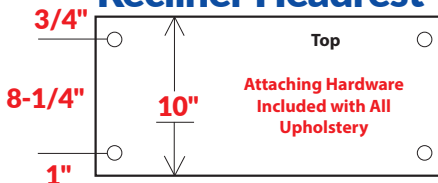

#### Backs

Flat	Embossed	Width
184-7CL	N/A	16"
132-8CL	N/A	18"
185-0CL	N/A	20"

Flat \$38.95 ea.  
Embossed \$42.95 ea.

187-710-CL	Embossed	16" wide	\$22.50 ea.
187-711-CL	Embossed	18" wide	Disc.
187-712-CL	Embossed	20" wide	Disc.
187-713-CL	Flat	18" wide	\$16.87 ea.

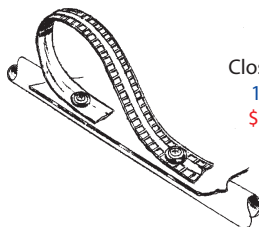

Closing Strap  
139-1CL  
\$8.96 ea.

# E&J Traveler HD 20", 22" & 24" Upholstery

## Back Upholstery

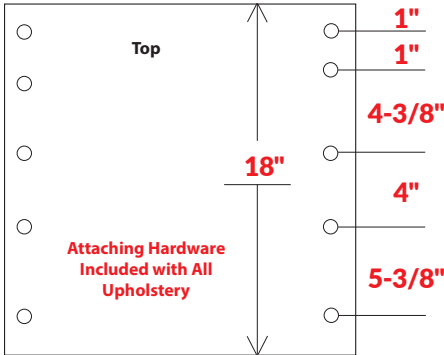

## Seat Upholstery

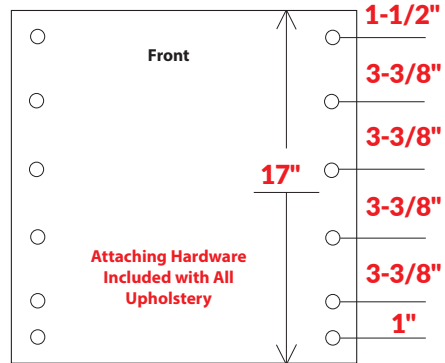

5 Hole pattern omits the back hole while the seat depth remains the same.

### Backs - 18" Height

P/N	Width	Price
187-703-CL	20"	\$29.95 ea.
187-704-CL	22"	\$36.95 ea.
187-705-CL	24"	\$36.95 ea.

### Seats - 17" Depth

P/N	Width	Holes	Price
187-706-CL	20"	5	\$29.95 ea.
187-707-CL	22"	6	\$36.95 ea.
187-708-CL	24"	6	\$36.95 ea.

# E&J Metro Upholstery

## Seat Upholstery

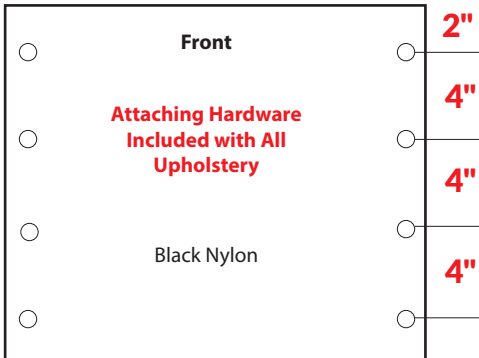

## Back Upholstery

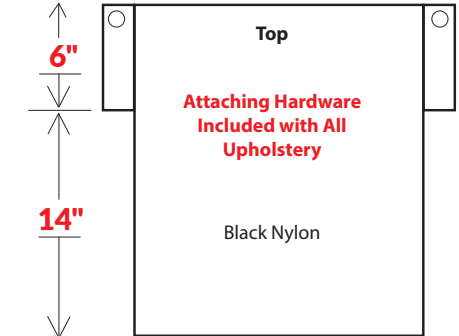

### Seats - 16" Depth

P/N	Width	Price
187-714-48	16"	\$54.95 ea.
187-715-48	18"	\$54.00 ea.
187-716-48	20"	\$54.00 ea.

### Backs - 20" Height

P/N	Width	Price
187-717-48	16"	\$54.00 ea.
187-718-48	18"	\$43.95 ea.
187-719-48	20"	\$43.95 ea.

## Mobile Stair Lifts

Genesis Mobile Stairlifts are designed to help transport riders up and down stairs safely and efficiently. They are lightweight and portable for use in many different settings.

**Price: \$4,205.49**

**SKU: 020-111**



# Invacare Style Fits Invacare, Old Theradyne, Drive, Colson, Futuro, Medline, Rolls, Metal Matic, Mobilaid, Will Ross, Sunmark

## Back Upholstery

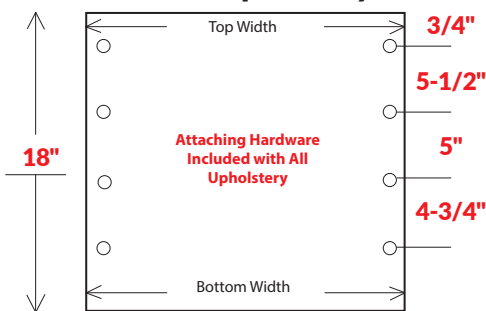

## Seat Upholstery

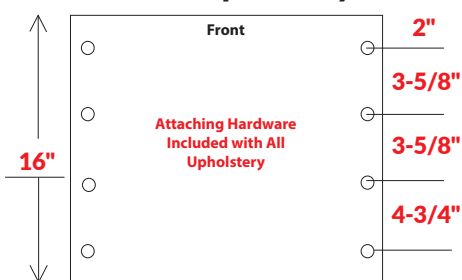

See Page 69 for Colors

Flat	Embossed	Top Width	Bottom Width
130-1CL	182-0CL	16"	16"
134-7CL	182-1CL	17"	16"
134-8CL	N/A	18"	16"
130-2CL	135-1CL	18"	18"
134-2CL	135-2CL	19"	18"
130-3CL	N/A	20"	18"
134-5CL	182-3CL	20"	20"
134-6CL	182-4CL	21"	20"
182-5CL	182-6CL	23"	22"
182-7CL	182-8CL	25"	24"

Flat	Embossed	Width
131-1CL	182-9CL	16"
131-2CL	135-4CL	18"
131-3CL	183-0CL	20"
183-3CL	183-4CL	22"
183-7CL	N/A	24"

### Upholstery Pricing (16" to 20" Wide)

Type	Flat	Embossed
Seat	\$29.95 ea.	\$31.95 ea.
Back	\$29.95 ea.	\$31.95 ea.

### Upholstery Pricing (22" to 24" Wide)

Type	Flat	Embossed
Seat	\$36.95 ea.	\$43.95 ea.
Back	\$36.95 ea.	\$43.95 ea.

- P Back With Pouch (flat only) Add \$13.00 ea.
- Z Back With Zipper (flat only) Add \$29.00 ea.

## Invacare 9000/SX5 Series Upholstery

### Wrap Around Back

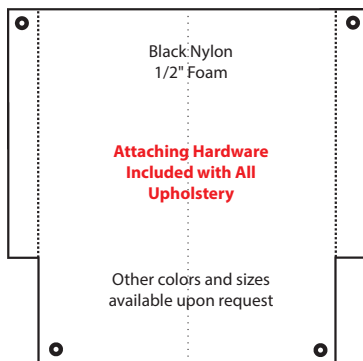

### Seat

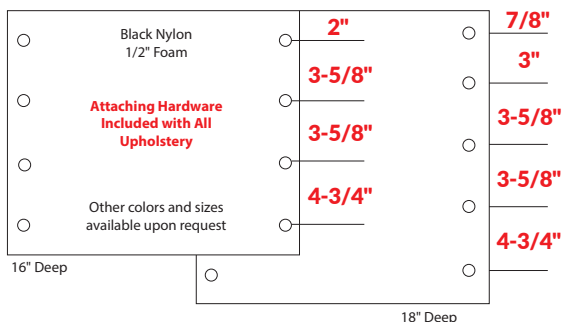

### Wrap Around Back

186-448	16" Wide Chair	\$43.95 ea.
186-348	18" Wide Chair	\$43.95 ea.
187-848	20" Wide Chair	\$43.95 ea.

### Seat - 16" Deep

131-1CL	16" Wide Chair	\$29.95 ea.
131-2CL	18" Wide Chair	\$29.95 ea.

### Seat - 18" Deep

186-5CL	18" Wide Chair	\$36.95 ea.
186-6CL	20" Wide Chair	\$36.95 ea.
186-7CL	22" Wide Chair	\$36.95 ea.

## Invacare Tracer IV Seat Upholstery

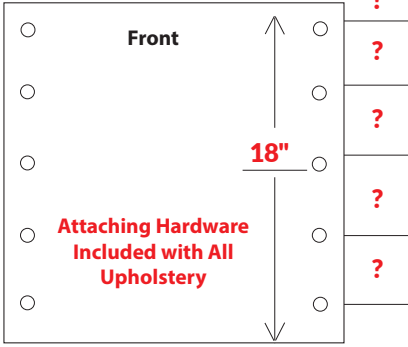

**Upholstery Pricing (16" to 20" Wide)**

Type	Flat	Embossed
Seat	\$29.95 ea.	\$36.95 ea.
Back	\$29.95 ea.	\$36.95 ea.

**Upholstery Pricing (22" to 24" Wide)**

Type	Flat	Embossed
Seat	\$36.95 ea.	\$43.95 ea.
Back	\$36.95 ea.	\$43.95 ea.

Before Oct 2003 Invacare Tracer IV Seat Uph.  
Hole spacing Front to Back (5 hole seat)  
**1-3/4" to 3-5/8" to 3-5/8" to 4-3/4" to 3-1/2"**  
Seat Depth 18"

Flat	Width
183-1CL-01	20"
183-5CL-01	22"
183-9CL-01	24"

Hole spacing Front to Back (5 hole seat)  
**2" to 3-5/8" to 3-5/8" to 4-3/4" to 3-3/8"**  
Seat Depth 18"

Flat	Embossed	Width
183-1CL-04	183-2CL-04	20"
183-5CL-04	183-6CL-04	22"
183-9CL-04	184-0CL-04	24"

After Oct 2003 Invacare Tracer IV Seat Uph.  
Hole spacing Front to Back (5 hole seat)  
**1 1/2" to 3 1/2" to 3 1/2" to 4 3/4" to 3 1/2"**  
Seat Depth 18"

Flat	Width
183-1CL-02	20"
183-5CL-02	22"
183-9CL-02	24"

After Oct 2003 Invacare Tracer IV Seat Uph.  
Hole spacing Front to Back (5 hole seat)  
**1" to 3-1/8" to 3-5/8" to 3-5/8" to 4-3/4"**  
Seat Depth 18"

Flat	Embossed	Width
183-1CL-03	183-2CL-03	20"
183-5CL-03	183-6CL-03	22"
183-9CL-03	184-0CL-03	24"

**Bariatric upholstery** is made with non-magnetic components to be used on MRI compatible wheelchairs.

### Backs

Embossed	Width	Price
188-2CL	24"	\$298.70 ea.
188-4CL	26"	\$298.70 ea.

### Solid Seats

Embossed	Width	Depth	Price
188-3CL	24"	18"	\$526.33 ea.
188-5CL	26"	18"	\$526.33 ea.

## Invacare 9000/SX5 Series Upholstery

### Back Upholstery

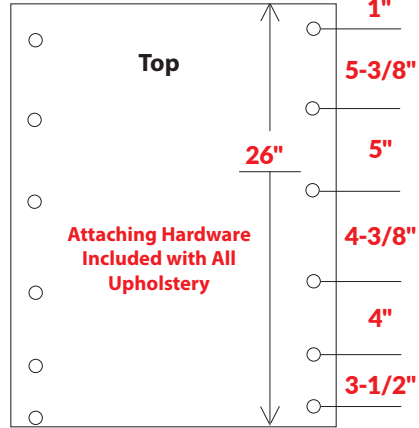

Flat	Embossed	Width
188-614-CL	188-714-CL	14"
188-616-CL	188-716-CL	16"
188-618-CL	188-718-CL	18"
188-620-CL	188-720-CL	20"
188-622-CL	188-722-CL	22"

**Upholstery Pricing (14" to 22" Wide)**

Back	Flat	Embossed
	\$36.95 ea.	\$61.95 ea.

## MRI Wheelchairs Non-Magnetic Upholstery

Upholstery is made with non-magnetic components to be used on MRI compatible wheelchairs.

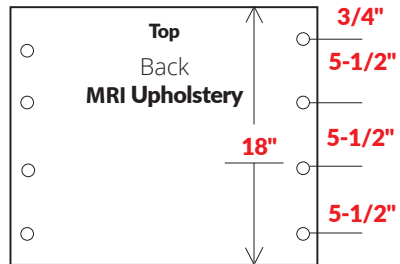

Embossed	Width	Price
187-0CL	18"	\$192.61 ea.
134-3CL	20"	\$261.62 ea.
187-2CL	22"	\$269.86 ea.
188-0CL	24"	\$298.70 ea.

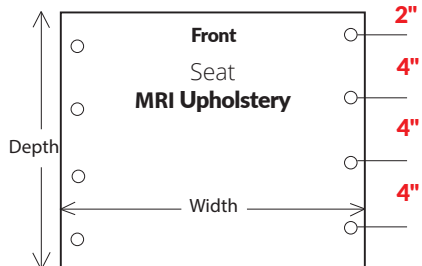

Embossed	Width	Depth	Price
134-0CL	18"	16"	\$146.26 ea.
134-4CL	20"	16"	\$216.30 ea.
134-1CL	22"	18"	\$215.27 ea.
188-1CL	24"	18"	\$238.96 ea.

# Quickie Upholstery

## Breezy 100 and 150 Series

**Seat for 100 and 150 Series**

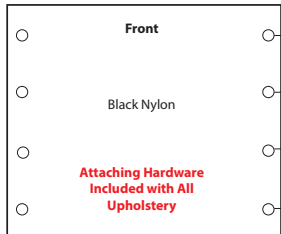

**Back for the 100 Series**

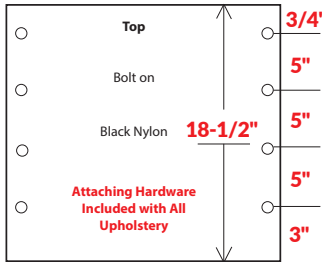

**Back for the 150 Series**

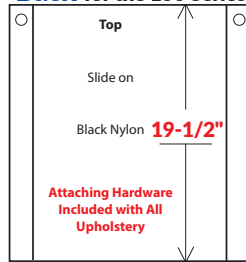

**Seats**  
**P/N**

131-148  
131-248  
131-348

**Width Price**

16" Disc.  
18" Disc.  
20" Disc.

**Backs**

P/N  
187-723-48  
187-724-48  
187-725-48

**Width Price**

16" \$44.00 ea.  
18" \$44.00 ea.  
20" \$54.00 ea.

**Backs**

P/N  
187-726-48  
187-727-48  
187-728-48

**Width Price**

16" Disc.  
18" \$36.95 ea.  
20" Disc.

## Breezy 500, 510 and 600 Series

**Seat for 500, 510 and 600 Series**

500 Series Seats are only 16" Deep

**Back for 500, 510 and 600 Series**

**A**

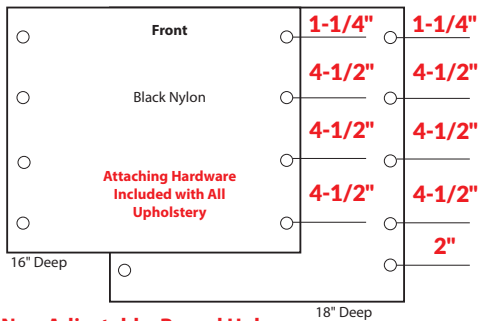

Non-Adjustable, Round Holes

**B**

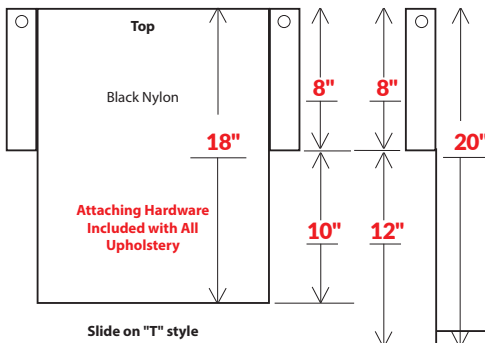

**Seats**

P/N	Width	Depth	Price
187-729-48	16"	16"	\$29.95 ea.
187-730-48	16"	18"	\$54.00 ea.
187-731-48	18"	16"	\$29.95 ea.
187-732-48	18"	18"	\$54.00 ea.
187-733-48	20"	16"	\$54.00 ea.
187-734-48	20"	18"	\$29.95 ea.

**A**

**Manufacturers**

Backs P/N	Specifications		Finished Specs		Price
	Width	Height	Width	Height	
187-735-48	16"	17"	17"	18"	\$38.95 ea.
187-736-48	16"	19"	17"	20"	\$36.95 ea.
187-737-48	18"	17"	19"	18"	\$54.00 ea.
187-738-48	18"	19"	19"	20"	Disc.
187-739-48	20"	17"	21"	18"	\$54.00 ea.
187-740-48	20"	19"	21"	20"	Disc.

**B**

# Upholstery/Armrest Set

## Set Includes:

- 1 ea. Wheelchair Upholstery Seat
- 1 ea. Wheelchair Upholstery Std. Back
- 2 ea. Padded Desk or Full Length Armrests

## All Attaching Hardware for Upholstery and Armrests

Find the set that meets your needs bellow. If you need help finding the set you need, please give us a call toll free **800-328-5343** and we will be happy to help you.

## Sets With Desk Length Arms

### Flat Upholstery Sets

#### Everest & Jennings Sets

139-4CL Narrow Adult 16" Set	\$64.25 ea.
139-5CL Adult 18" Set	\$64.25 ea.
133-5CL Adult 20" Set	\$63.25 ea.

#### Invacare Sets

138-2CL N. A. 16" with Std. Back Set	\$64.25 ea.
131-0CL Adult 16" with 1" Flare Back Set	\$63.25 ea.
131-9CL Adult 16" with 2" Flare Back Set	\$63.25 ea.
138-3CL Adult 18" with Std. Back Set	\$64.25 ea.
138-4CL Adult 18" with 1" Flare Back Set	\$64.25 ea.
138-5CL Adult 18" with 2" Flare Back Set	\$64.25 ea.
131-4CL Adult 20" with Std. Back Set	\$63.25 ea.
131-6CL Adult 20" with 1" Flare Back Set	\$63.25 ea.

### Embossed Upholstery Sets

#### Everest & Jennings Sets

133-0CL Adult 18" Set	\$77.95 ea.
-----------------------	-------------

#### Invacare Sets

133-7CL Adult 18" with Std. Back Set	\$77.95 ea.
133-8CL Adult 18" with 1" Flare Back Set	\$77.95 ea.
133-9CL Adult 18" with 2" Flare Back Set	\$77.95 ea.

## Sets With Full Length Arms

### Flat Upholstery Sets

#### Everest & Jennings Sets

139-6CL Narrow Adult 16" Set	\$64.25 ea.
139-7CL Adult 18" Set	\$64.25 ea.
133-6CL Adult 20" Set	\$63.25 ea.

#### Invacare Sets

138-6CL N. A. 16" with Std. Back Set	\$64.25 ea.
132-0CL Adult 16" with 1" Flare Back Set	\$63.25 ea.
132-9CL Adult 16" with 2" Flare Back Set	\$63.25 ea.
138-7CL Adult 18" with Std. Back Set	\$64.25 ea.
138-8CL Adult 18" with 1" Flare Back Set	\$64.25 ea.
138-9CL Adult 18" with 2" Flare Back Set	\$64.25 ea.
131-5CL Adult 20" with Std. Back Set	\$63.25 ea.
131-7CL Adult 20" with 1" Flare Back Set	\$63.25 ea.

### Embossed Upholstery Sets

#### Everest & Jennings Sets

135-0CL Adult 18" Set	\$77.95 ea.
-----------------------	-------------

#### Invacare Sets

135-7CL Adult 18" with Std. Back Set	\$77.95 ea.
135-8CL Adult 18" with 1" Flare Back Set	\$77.95 ea.
135-9CL Adult 18" with 2" Flare Back Set	Disc.

## Upholstery Colors

67 Regal (Dk. Blue)

68 Royal Blue (Med. Blue)

64 Avalon (Lt. Blue)

83 Nutmeg ( Brown Orange)

82 Camel (Med. Brown)

27 Burgundy (Dk. Red)

96 Beige (Off White)

54 Cactus (Med. Green)

46 Black

48 Black Nylon

44 Grey

## Quickie Breezy 500, 510 and 600 Series

### Black Nylon - Full Length Armrests

#### 20" Tall Back

P/N	Width	Depth	Price
187-741-48	16"	16"	\$81.00 Set
187-742-48	18"	16"	\$81.00 Set

### Black Nylon - Desk Length Armrests

#### 20" Tall Back

P/N	Width	Depth	Price
187-743-48	16"	16"	\$81.00 Set
187-744-48	18"	16"	\$81.00 Set

# Invacare Most Common Brakes

## Chrome Finish

**For Fixed Arm Chair**  
Left or Right, Specify

**\$19.22 ea.**  
**151-111-SD**



**For Detachable Arm Chair**  
Left or Right, Specify

**\$15.47 ea.**  
**151-121-SD**



**A**



**B**



**C**

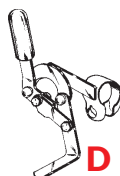

**D**



**E**



**F**



**G**

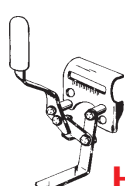



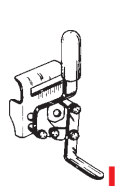

**H**

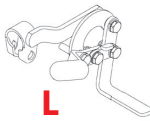

**I**

If the part you are looking for is not illustrated or you can not find what you need, let us help!  
**Call toll free 1-800-328-5343**

	Part #	Finish	Arm Style	Locking	Price
	<b>A</b> 151-461-SD	Chrome	Detach Arm	Push To Lock	\$46.38 ea.
	<b>B</b> 151-311-SD	Chrome	Fixed Arm	Push To Lock	\$22.39 ea.
	<b>C</b> 151-021-SD	Chrome	Detach Arm	Push To Lock	\$23.59 ea.
	151-463-SD	Chrome	Detach Arm	Pull To Lock	Disc.
	<b>D</b> 151-401-SD	Chrome	Fixed Arm	Pull To Lock	Disc.
	<b>E</b> 151-411-SD	Chrome	Fixed Arm	Push To Lock	\$101.29 ea.
	151-413-SD	Chrome	Detach Arm	Push To Lock	\$65.81 ea.
	<b>F</b> 151-415-SD	Chrome	Fixed Arm	Pull To Lock	Disc.
	151-417-SD	Chrome	Detach Arm	Pull To Lock	Disc.
	<b>G</b> 151-111-SD	Chrome	Fixed Arm	Push To Lock	\$19.22 ea.
	151-431-SD	Black	Fixed Arm	Push To Lock	\$70.20 ea.
	151-433-SD	Chrome	Detach Arm	Push To Lock	\$42.06 ea.
	151-435-SD	Black	Detach Arm	Push To Lock	\$70.20 ea.
	<b>H</b> 151-441-SD	Chrome	Fixed Arm	Pull To Lock	\$67.14 ea.
	151-443-SD	Black	Fixed Arm	Pull To Lock	\$70.20 ea.
	151-445-SD	Chrome	Detach Arm	Pull To Lock	\$42.06 ea.
	151-447-SD	Black	Detach Arm	Pull To Lock	\$70.20 ea.
	<b>I</b> 151-451-SD	Chrome	Detach Arm	Pull To Lock	Disc.
	<b>J</b> 151-134-SD	Chrome	Det. Flip Back Arm	Push To Lock	\$49.48 ea.
	<b>K</b> 151-136-SD	Chrome	Det. Flip Back Arm	Pull To Lock	\$46.53 ea.
	<b>L</b> 151-138-SD	Chrome	Recliner		\$65.81 ea.
	<b>M</b> 151-130-SD	Black	Hemi, Disk	Pull To Lock	Disc.
	151-132-SD	Black	Standard, Disk	Push To Lock	Disc.

## Universal Wheelchair Brake Extensions **A**

### Features:

Available in three lengths  
Available in two slot sizes  
Available with or without elastic cord

### Elastic Cord

The elastic cord connects the extension to the brake. This helps to hold the extension on the brake.

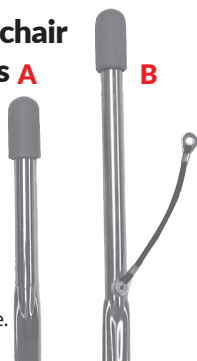

### A. Without Elastic Cord

- 6" Extension with 1/8" Slot Size **\$6.19** 154-102
- 6" Extension with 3/16" Slot Size 154-105
- 8" Extension with 1/8" Slot Size 154-101
- 8" Extension with 3/16" Slot Size 154-104
- 10" Extension with 1/8" Slot Size 154-100
- 10" Extension with 3/16" Slot Size 154-103

### B. With Elastic Cord

- 6" Extension with 1/8" Slot Size **\$10.59** 154-108
- 6" Extension with 3/16" Slot Size 154-111
- 8" Extension with 1/8" Slot Size 154-107
- 8" Extension with 3/16" Slot Size 154-110
- 10" Extension with 1/8" Slot Size 154-106
- 10" Extension with 3/16" Slot Size 154-109



### Quickie Wheelchair Brake Extensions



**Brake Extension** \$41.53 pr.  
6" Extension 154-200

### Universal Strap Mount Brake

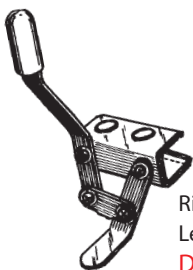

**Strap** 159-100 \$5.59 ea.  
**Comes with attaching hardware**



Right 153-001-R  
Left 153-001-L  
Disc.

### Universal Strap Mount Brake

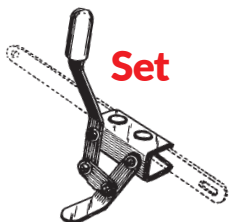

**Set**

**Set Includes:**  
1 ea. 153-001-R Right Brake  
1 ea. 153-001-L Left Brake  
2 ea. Mounting Straps  
**All attaching hardware**  
153-010 Disc.

### Medline

**Vertical Bolt for K4**

(shown) 151-001 Disc.

**Horizontal Bolt**  
(not shown)

151-002 \$37.87 pr.



### Everest & Jennings



**Bar Mount**

\$15.73 ea.

Fixed Arm, Right 150-011-R  
Fixed Arm, Left 150-011-L  
Detach Arm, Right 150-021-R  
Detach Arm, Left 150-021-L

**Strap Mount**

\$19.73 ea.

Right 150-111-R  
Left 150-111-L

Strap Mount



Bar Mount

### MRI Non-Magnetic Wheelchair Brake



made with non-magnetic components to be used on MRI compatible wheelchairs

Left 150-031-L  
Right 150-031-R  
\$76.79 ea.

### Quickie Brakes

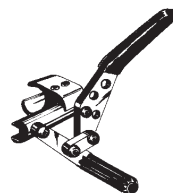

Left 153-201-L  
Right 153-201-R  
\$30.20 ea.

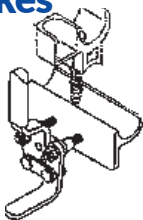

**Breezy 500/510/2/600**  
Push-To-Lock 153-203  
\$99.75 pr.

### Theradyne

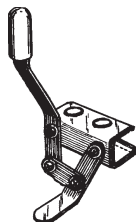

Left 153-001-L  
Right 153-001-R  
Disc.

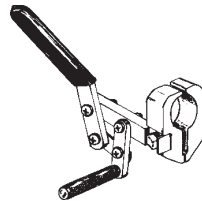

Left 153-101-L  
Right 153-101-R  
\$46.12 ea.

### Gendron



152-001-R Right  
152-001-L Left  
Disc.

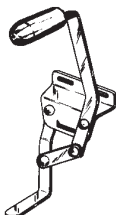

152-101-R Right  
152-101-L Left  
Disc.



152-201-R Right  
152-201-L Left  
\$15.59 ea.

### Wheel Lock Shoe Spacer

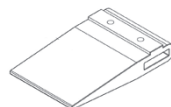

**Includes hardware**

154-114 1-45/64" Long  
\$28.82 ea.  
154-115 2-7/16" Long  
\$25.07 ea.

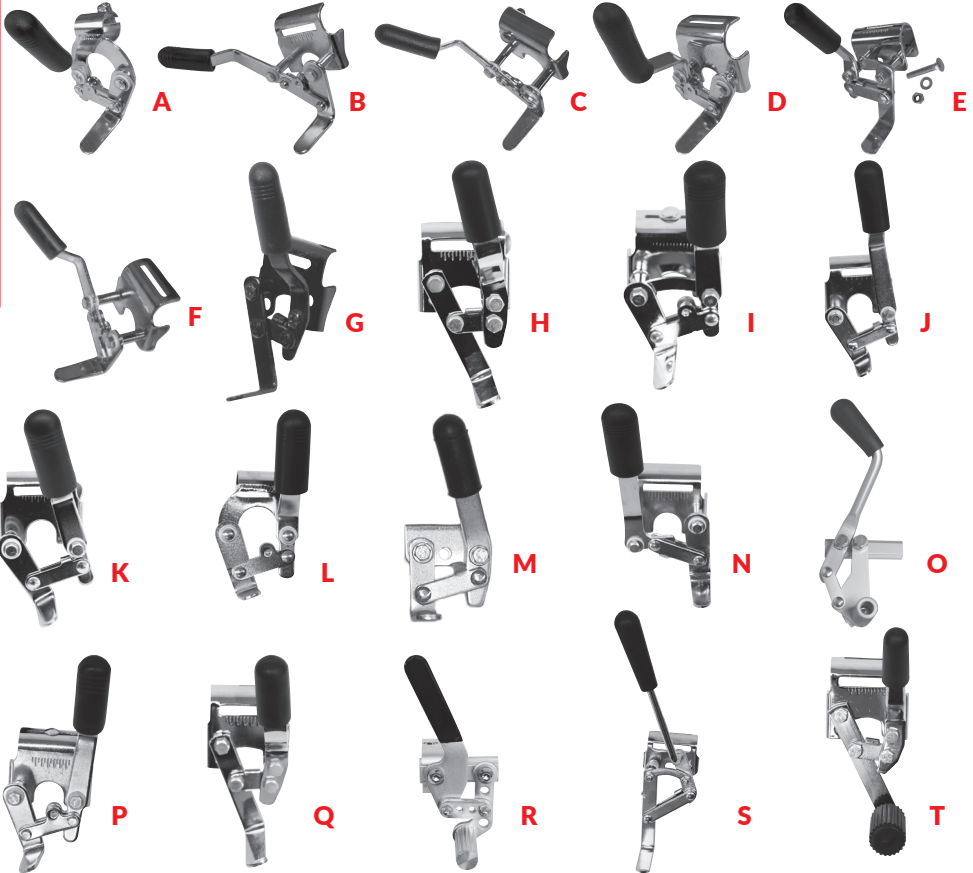

**Specify Left or Right when Ordering Brakes** (determine left or right when sitting in chair)

	<b>Part #</b>	<b>Fits Wheelchairs</b>	<b>Arm Style</b>	<b>Price</b>
<b>A</b>	151-129-SD	Winnie	Fixed Arm	\$24.22 ea.
<b>B</b>	151-124-SD	Winnie & Sentra HD	Detach Arm	\$23.22 ea.
<b>C</b>	151-123-SD	Sentra EC (side mount)	Detach Arm	\$20.17 ea.
<b>D</b>	151-125-SD	Sentra Plus, Cirrus III & Astaire	Detach Arm	\$20.15 ea.
<b>E</b>	151-126-SD	Cirrus IV	Detach Arm	Disc.
<b>F</b>	151-127-SD	Viper & Viper Plus (top mount)	Slope Arm	\$20.17 ea.
<b>G</b>	151-110-SD	Silver Sport I, Silver Sport II & Cruiser III	Detach Arm	\$21.24 ea.
<b>H</b>	151-140-SD	Sentra EC (side mount)	Fixed Arm	\$20.17 ea.
<b>I</b>	151-142-SD	Sentra HD EC Extra Wide (top mount)	Detach Arm	\$21.33 ea.
<b>J</b>	151-144-SD	Sentra 26", 28" & 30" Wide Chairs (side mount)	Detach Arm	\$20.98 ea.
<b>K</b>	151-146-SD	Winnie (side mount)	Detach Arm	\$24.39 ea.
<b>L</b>	151-148-SD	Winnie (side mount)	Fixed Arm	\$22.49 ea.
<b>M</b>	151-150-SD	Winnie II (top mount) Extended Back	Fixed Arm	Disc.
<b>N</b>	151-152-SD	Viper (non-slope arms, top mount) Not 12" or 14" chairs	Flip Back Arm	\$21.33 ea.
<b>O</b>	151-154-SD	Viper (non-slope arms, top mount) ONLY 12" or 14" chairs	Flip Back Arm	\$23.69 ea.
<b>P</b>	151-156-SD	Viper & Viper Plus Recliner (top mount)	Detach Arm	\$21.33 ea.
<b>Q</b>	151-158-SD	Cirrus III (side mount)	Flip Back Arm	Disc.
<b>R</b>	151-160-SD	Cougar (side mount)	Detach Arm	\$24.22 ea.
<b>S</b>	151-162-SD	Silver Sport Recliners (side mount)	Detach Arm	\$21.44 ea.
<b>T</b>	151-164-SD	Blue Streak	Detach Arm	\$33.64 ea.

## Spacers - Screws - Clips

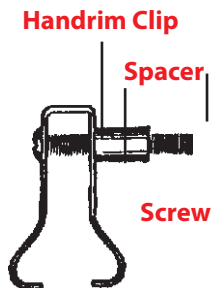

### White Nylon Spacers

Size	Part#	Price
1/2"	166-311	\$.61 ea.
5/8"	166-312	\$.41 ea.
3/4"	166-313	\$.41 ea.
7/8"	166-314	\$.41 ea.
1"	166-315	\$.41 ea.

### Aluminum Spacers

Size	Part #	Price
1/2"	166-301	\$.56 ea.
5/8"	166-302	\$.56 ea.
3/4"	166-303	\$.56 ea.
7/8"	166-304	\$.56 ea.
1"	166-305	\$.69 ea.

### Screws

Size	Part #	Price
1-3/8"	166-306	\$.26 ea.
1-1/2"	166-307	\$.26 ea.
1-3/4"	166-309	\$.26 ea.
1-7/8"	166-310	\$.26 ea.

## MRI Non-Magnetic Wheelchair Spacers - Screws - Clips

### MRI Non-Magnetic Hand Rim Screws and Spacers

2" Screws, 3/4" Spacers  
8 screws, 8 spacers  
166-319 \$53.01 ea.

### Universal Handrim Clip

166-300 \$3.29 ea.



**Can't find what you're looking for?  
Let us make it for you!**

Ocelco has its own in house Wood Shop and Custom Upholstery Shop. Let us know what you need and we will make it for you. Special size wheelchair upholstery, custom cushions (see page 56-57), adaptive seating, or whatever you may need. Let Ocelco make it to your specifications. We're here to help, please do not hesitate to call us so we can make your special request for you.

Remember "We're The Friendly People"

Visit our online store at [www.WheelchairParts.com](http://www.WheelchairParts.com)  
or [www.ocelco.com](http://www.ocelco.com) for many more products and choices

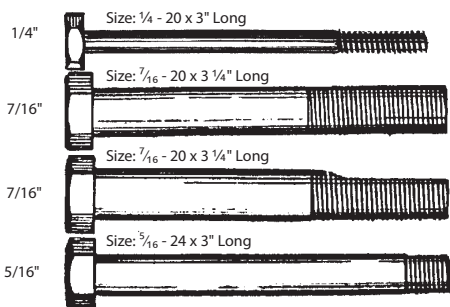

**American 8" Wheel Axle**

164-000 \$ .65 ea.

**Theradyne Old Style**

164-170 \$1.50 ea.

**Invacare Shaved Axle**

164-181 \$1.75 ea.

**E&J 8" Wheel & Cross Brace**

164-480 \$1.66 ea.

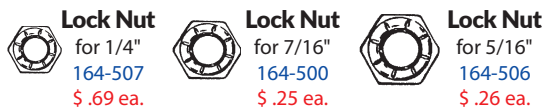

**Quick Release Axles**

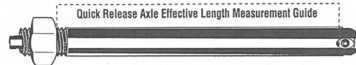

Quick Release Axle Effective Length Measurement Guide		
Not actual size - for reference only		
	Size	
*164-400	7/16" x 4"	Disc.
*164-401	7/16" x 4-3/8"	Disc.
164-402	7/16" x 4-1/2"	Disc.
164-403	1/2" x 4-1/4"	Disc.
*164-404	1/2" x 4-3/8"	Disc.
164-405	1/2" x 4-3/4"	Disc.
164-406	1/2" x 5"	Disc.

**\*Common to Invacare**



**Drive Front Axle**  
164-100 \$20.66 ea.



**Drive/Medline Rear Axle & Nut for 24" Wheels**  
164-101 \$10.07 ea.

**Everest & Jennings 24" Wheel Axles and Nuts**

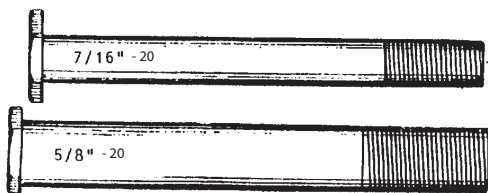

Length	Part #	Price
4-1/4"	164-130	Disc.
5"	164-160	\$6.63 Set

**Nuts Included with E&J Axles**

Length	Part #	Price
4-1/4"	164-340	\$7.69 ea.
5"	164-360	\$6.80 ea.



**24" Wheel Standard Axles**

All Standard Axles Run Every 1/4" From 3-3/4" To 5"



Length	Part #	Price
3-3/4"	164-111	\$1.06 ea.
4"	164-121	\$1.06 ea.
4-1/4"	164-131	\$1.95 ea.
4-1/2"	164-141	\$3.83 ea.
4-3/4"	164-151	\$1.58 ea.
5"	164-161	\$2.81 ea.

Standard Nut	Lock Nut
164-501 \$.26 ea.	164-500 \$.25 ea.



Length	Part #	Price
3-3/4"	164-211	\$1.62 ea.
4"	164-221	\$2.37 ea.
4-1/4"	164-231	\$3.29 ea.
4-1/2"	164-241	\$4.75 ea.
4-3/4"	164-251	\$2.84 ea.
5"	164-261	\$2.17 ea.

Standard Nut	Lock Nut
164-502 \$.26 ea.	164-503 \$.89 ea.



Length	Part #	Price
3-3/4"	164-311	\$2.45 ea.
4"	164-321	\$4.39 ea.
4-1/4"	164-331	\$2.06 ea.
4-1/2"	164-341	\$2.44 ea.
4-3/4"	164-351	\$3.17 ea.
5"	164-361	\$3.17 ea.

Standard Nut	Lock Nut
164-504 \$.42 ea.	164-505 \$1.28 ea.

**Note:** Measure the shaft only on the axles above, **DO NOT** include the head.

## MRI Non-Magnetic Axles for MRI Wheelchairs

### Axle and Nut for 8" Front Wheel

fits MRI Wheelchairs

Axle Size: 5/16" x 3-3/4" Long

164-490 \$29.04 ea.



### Axle and Nut for 24" Rear Wheel

Axle Size: 7/16" x 5" Long

fits 18" to 20" MRI Wheelchairs

164-491 \$59.34 ea.

Axle Size: 5/8" x 5" Long

fits 22" to 26" MRI Wheelchairs

164-492 \$143.53 ea.

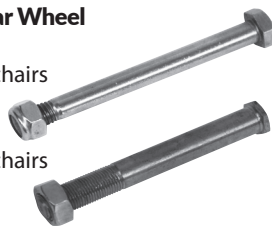

## 24", 22" & 8" Vice Tire Setter

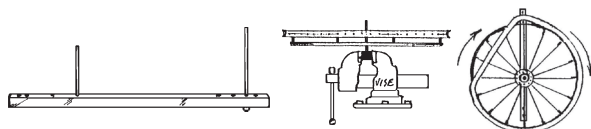

This tool makes it easy to put on Snap-On Tires that almost seem impossible to put on by hand.

510-102 \$63.47

## Valve Caps

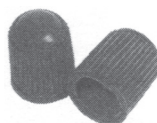

Plastic

510-151

\$.67 ea.

## Rim Strips

Simple to use, rim strips stretch to securely fit around your rims and protect your tubes from spoke heads.

### Rim Strip

20"	163-122	\$1.62 ea.
20" x 2-1/8"	163-124	\$1.62 ea.
22"	163-123	\$1.62 ea.
24"	163-100	\$1.39 ea.
24" x 3/4"	163-001	\$1.39 ea.



## Air Pump with Gauge

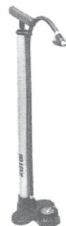

510-150

Disc.

## Lever Bar



Slotted head slides easily along rim

510-149 \$19.46 ea.

## Spoke Wrench

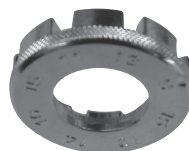

Universal to fit most spoke sizes.

510-100 \$6.80 ea.

## Everest & Jennings

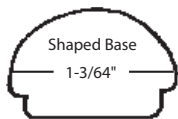

162-101 24" Snap on tire  
Disc.  
162-201 22" Snap on tire  
Disc.

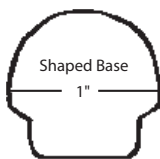

162-103 24" Snap on tire  
Disc.

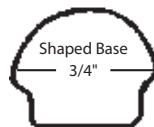

Light Weight  
162-108 24" Snap on tire  
Disc.

## Smith & Davis

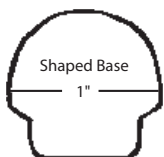

162-203 22" Snap on tire  
Disc.

## 8" Snap-On-Tire

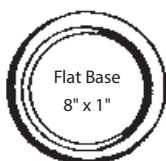

Fits: Most Chairs  
162-109 8" Snap on tire  
Disc.

## Invacare

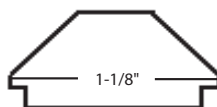

Invacare Low Profile DTM Tire,  
Black  
162-116 20" Snap-On-Tire Disc.  
162-115 22" Snap-On-Tire Disc.  
162-111 24" Snap-On-Tire Disc.

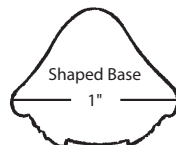

DTM Tire  
162-110  
24" Snap on tire  
\$28.22

## Snap-On-Tire Tool Easy To Use

One stem will go through the center bearing of the wheel. The wheel will spin on this stem. The bearing fit will not necessarily be a tight fit on the stem. The stem is only used to rotate the wheel. The other stem will go between the wheel and the tire being mounted. This stem will draw the tire onto the wheel with ease while rotating the wheel.

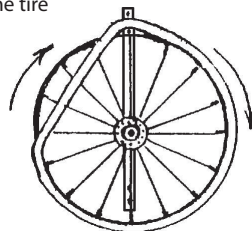
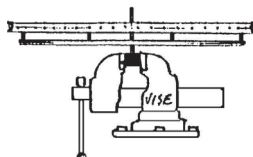
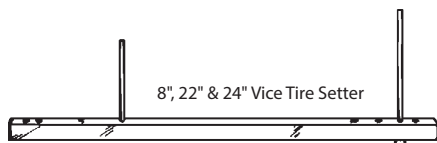

510-102  
\$63.47

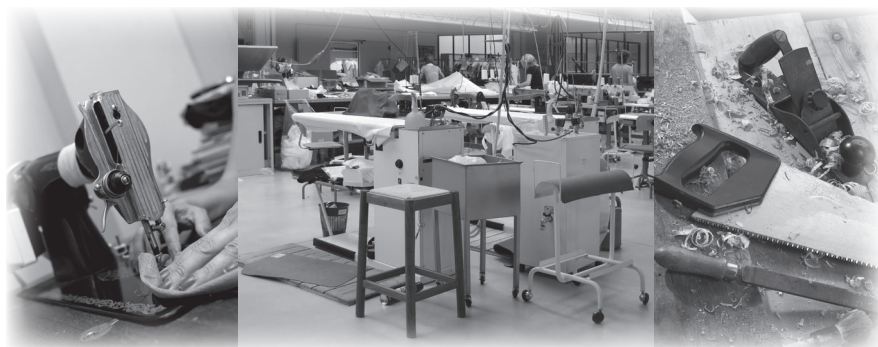

**Can't find what you're looking for?  
Let us make it for you!**

Ocelco has its own in house Wood Shop and Custom Upholstery Shop. Let us know what you need and we will make it for you. Special size wheelchair upholstery, custom cushions (see page 56-57), adaptive seating, or whatever you may need. Let Ocelco make it to your specifications. We're here to help, please do not hesitate to call us so we can make your special request for you.

Remember "We're The Friendly People"

# Pneumatic Tires, Poly Foam Filled Tires, Flat-Free Inserts & Tubes

**Pneumatic Tires** - Require a tube or flat free poly foam insert

**Poly Foam Filled Tire** - Tire filled with poly foam - typically works with 2 piece hubs

**Tube** - Air filled and inserts inside of pneumatic tire

**Flat Free Inserts** - Made of poly foam and can be inserted into existing tire



Size	Description	Fits	Fig.	Part#	Price
6" x 1-1/4"	Pneumatic Tire	Most	A	163-181	\$14.26 ea.
6" x 1-1/4"	Tube 45 Deg. Valve	Most 6" Casters		163-191	\$8.79 ea.
6" x 1-1/4"	Flat Free Insert	Most 6" Casters		163-209	Disc.
7" x 1-3/4"	Pneumatic Tire	8" x 2" Wheels and Shepher/Meyra	A	163-133	Disc.
7" x 1-3/4"	Tube 90 Deg. Valve	Most		163-134	Disc.
8" x 1-1/4"	Pneumatic Tire	Most Casters Include Quickie	A	163-106	\$9.51 ea.
8" x 1-1/4"	Tube 45 Deg. Valve	Most		163-111	\$9.35 ea.
8" x 1-1/4"	Flat Free Insert	Most		163-208	\$20.81 ea.
8" x 1-3/4"	Pneumatic Tire (200x44)	Most	A	163-107	\$23.21 ea.
8" x 1-3/4"	Urethane Tire, Dark Grey	Most	T	163-109	Disc.
8" x 1-3/4"	Tube (200x50), 90 Deg. Valve	Most		163-112	Disc.
8" x 1-3/4"	Flat Free Insert	Most, Including E&J 2-Piece Hub		163-210	Disc.
8" x 2"	Pneumatic Tire (200x50)	Most	A	163-108	\$20.02 ea.
8" x 2"	Poly Foam Filled Tire (200x50)	Most		163-110	\$30.85 ea.
8" x 2"	Tube (200x50) 70 Deg. Valve	Most		163-113	\$6.63 ea.
8" x 2"	Tube (200x50) 90 Deg. Valve	Most		163-125	\$11.28 ea.

**Pneumatic Tires** - Require a tube or flat free poly foam insert

**Poly Foam Filled Tire** - Tire filled with poly foam - typically works with 2 piece hubs

**Tube** - Air filled and inserts inside of pneumatic tire

**Flat Free Inserts** - Made of poly foam and can be inserted into existing tire

## See Page 29 for Tread Patterns

Size	Description	Fits	Fig.	Part#	Price
9" x 3"	Pneumatic Tire (2.80/2.50-4)	Most Scooters	<b>A</b>	163-135	\$24.56 ea.
9" x 3"	Poly Foam Filled Tire - Sawtooth Tread	Most Power Chair Wheels Except P-300	<b>B</b>	163-136	\$43.80 ea.
9" x 3"	Poly Foam Filled Tire - Wide Sawtooth Tread	Inv. Storm, Lancer, Explorer and P-300	<b>B</b>	163-137	\$44.02 ea.
9" x 3"	Poly Foam Filled Tire - Wide Rib Tread	Invacare Storm	<b>A</b>	163-138	\$40.01 ea.
9" x 3"	Tube 90 Deg. Valve (2.80/2.50-4)	Most		163-139	\$10.93 ea.
10" x 3"	Pneumatic Tire (3.00-4) (260x85) Front	Fortress, Invacare	<b>A</b>	163-190	\$21.79 ea.
10" x 3"	Pneumatic Tire (3.00-4) (260x85) Rear	Fortress	<b>C</b>	163-140	\$21.68 ea.
10" x 3"	Poly Foam Tire (3.00-4) (260x85) Rear	Most	<b>C</b>	163-141	\$47.09 ea.
10" x 3"	Poly Foam Tire (3.00-4) (260x85) Front	Most	<b>A</b>	163-142	\$53.20 ea.
10" x 3"	Tube (3.00-4) (260x85) 90 Deg. Valve	Most		163-143	\$11.70 ea.
10"	Pneumatic Tire (410/350-4)	Ortho-Kinetics	<b>D</b>	163-144	\$23.80 ea.
10"	Pneumatic Tire (410/350-4)	Ortho-Kinetics, Sierra	<b>D</b>	163-145	\$57.15 ea.
11"	Pneumatic Tire (410/350-5)	Invacare and Others	<b>E</b>	163-147	\$26.70 ea.
12"	Pneumatic Tire (410/350-6) Saw Tooth Tread	Explorer, Lancer	<b>F</b>	163-150	\$26.53 ea.
10"	Tube (410/350-4) 90 Deg. Valve	Ortho-Kinetics		163-146	\$11.88 ea.
11"	Poly Foam Tire (410/350-5)	Invacare Storm and XT	<b>E</b>	163-148	\$60.83 ea.
11"	Tube (410/350-5) 90 Deg. Valve	Invacare		163-149	\$13.47 ea.
12"	Poly Foam Tire (410/350-6)	Explorer and Lancer	<b>E</b>	163-151	Disc.
12"	Tube (410/350-6) 90 Deg. Valve	Explorer, Lancer		163-152	\$13.47 ea.
12.5" x 2.25"	Pneumatic Tire Smooth Tread	Powerchairs, ABEC	<b>G</b>	163-153	\$24.39 ea.
12.5" x 2.25"	Pneumatic Tire	Powerchairs, Invacare and ABEC	<b>H</b>	163-128	\$24.35 ea.
12.5" x 2.25"	Tube, Straight Valve	Most		163-130	\$11.88 ea.
12.5" x 2.25"	Flat Free Insert	Most		163-201	\$37.47 ea.
13" x 4"	Pneumatic Tire (4.00-5)	Pride and Shoprider	<b>I</b>	163-154	\$27.04 ea.
13" x 4"	Poly Foam Tire (4.00-5)	Pride and Shoprider	<b>I</b>	163-155	\$77.89 ea.
13" x 4"	Tube (4.00-5) 90 Deg. Valve	Pride and Shoprider		163-156	\$14.13 ea.
14" x 2.125"	Pneumatic Tire	E&J	<b>J</b>	163-157	Disc.
14" x 2.125"	Flat Free Insert	E&J		163-211	Disc.
14" x 2-1/8"	Tube Straight Valve	E&J		163-158	Disc.
14" x 3"	Pneumatic Tire (3.00-8)	Storm and Permibile	<b>C</b>	163-159	\$28.65 ea.
14" x 3"	Poly Foam Tire (3.00-8)	Invacare Storm	<b>C</b>	163-160	\$62.43 ea.
14" x 3"	Tube (3.00-8) 90 Deg. Valve	Storm and Permibile		163-192	\$12.28 ea.
14" x 4"	Pneumatic Tire (4.00-6)	Invacare Storm	<b>I</b>	163-162	Disc.
14" x 4"	Poly Foam Tire (4.00-6)	Invacare Storm	<b>I</b>	163-163	\$82.59 ea.
14" x 4"	Tube (4.00-6) 90 Deg. Valve	Invacare Storm		163-164	\$14.13 ea.
16" x 1.75"	Pneumatic Tire	Specialty and Some Damaco Chairs	<b>R</b>	163-167	\$23.44 ea.
16" x 1.75"	Flat Free Insert	Most		163-212	\$48.64 ea.
16" x 1.75"	Tube Straight Valve	Most		163-168	Disc.



**Pneumatic Tires** - Require a tube or flat free poly foam insert

**Poly Foam Filled Tire** - Tire filled with poly foam - typically works with 2 piece hubs

**Tube** - Air filled and inserts inside of pneumatic tire

**Flat Free Inserts** - Made of poly foam and can be inserted into existing tire

## See Page 29 for Tread Patterns

Size	Description	Fits	Fig.	Part#	Price
16" x 1.25"	Pneumatic Tire	Most Pediatric Power Chairs	J	163-169	Disc.
16" x 1.25"	Tube Straight Valve	Most		163-170	Disc.
16" x 4"	Pneumatic Tire (400-8) (4.00-8)	Most	F	163-165	Disc.
16" x 4"	Tube	Most		163-166	\$17.24 ea.
18" x 2.125"	Pneumatic Tire	E&J Vortex	J	163-171	Disc.
18" x 2.125"	Tube	E&J Vortex		163-172	\$15.49 ea.
20" x 1-3/8"	Pneumatic Tire	Most	K	163-116	\$17.98 ea.
20" x 1-3/8"	Flat Free Insert	Most		163-202	\$25.30 ea.
20" x 1-3/8" & 1-1/4"	Tube	Most		163-119	\$7.08 ea.
20" x 1.75"	Pneumatic Tire	Skyway	U	163-173	Disc.
20" x 1.75"	Flat Free Insert	Most		163-203	Disc.
20" x 1.75"	Tube	Most		163-174	\$8.08 ea.
20" x 2.125"	Pneumatic Tire - Dark Grey	Most	J	163-175	Disc.
20" x 2.125"	Pneumatic Tire - Light Grey	Most	J	163-126	Disc.
20" x 2.125"	Flat Free Insert	Most		163-204	Disc.
20" x 2.125"	Tube	Most		163-120	\$7.34 ea.
22" x 1-3/8"	Pneumatic Tire (37-501) Light Grey	Most	L	163-117	\$17.66 ea.
22" x 1-3/8"	Flat Free Insert	Most		163-205	\$27.35 ea.
22" x 1-3/8"	Tube	Most		163-121	\$7.29 ea.
24" x 1-3/8" & 1-1/4"	Pneumatic Tire (37-547) Dark Grey	Most	M	163-176	Disc.
24" x 1-1/4"	Pneumatic Tire (32-547) Light Grey	Most	M	163-103	Disc.
24" x 1-1/4"	Pneumatic Tire (32-547) Light Grey, Smooth Trd	Most		163-105	\$24.89 ea.
24" x 1-3/8"	Pneumatic Tire (37-540) Light Grey	Most	N	163-177	Disc.
24" x 1-3/8"	Pneumatic Tire (37-540) Dark Grey	Most	N	163-178	Disc.
24" x 1-3/8"	Pneumatic Tire (37-540) Light Grey	Most	K	163-114	\$13.84 ea.
24" x 1-3/8"	Pneumatic Tire (32-540) Lt. Grey, Smooth Tread	Most	O	163-118	\$19.49 ea.
24" x 1-3/8" & 1-1/2"	Pneumatic Tire (40-540) Dk.Grey, All-Terrain Trd	Most	P	163-179	Disc.
24" x 1-3/8"	Pneumatic Tire (37-540) Knobby w/ Blackwall	Most	Q	163-180	\$22.87 ea.
24" x 1-3/8"	Flat Free Insert	Most		163-206	\$26.57 ea.
24" x 1-3/8" & 1-1/4"	Tube, Straight Valve	Most		163-101	\$5.44 ea.
24" x 1-3/4"	Pneumatic Tire	Older E&J	K	163-115	Disc.
24" x 1.75"	Pneumatic Tire (47-507)	Invare and Others	R	163-104	\$19.86 ea.
24" x 1.75"	Flat Free Insert	Most		163-207	Disc.
24" x 1.75"	Tube	Most		163-102	\$8.08 ea.
24" x 2.125"	Pneumatic Tire, Dark Grey	24 x 1/34" & 1-34" Wheels	S	163-182	Disc.
24" x 2.125"	Tube	Most		163-183	\$8.08 ea.
26" x 1-3/8"	Pneumatic Tire (37-590)	Most	K	163-184	\$18.96 ea.
26" x 1-3/8"	Flat Free Insert	Most		163-213	\$29.64 ea.
26" x 1-3/8"	Tube	Most		163-185	\$7.34 ea.
26" x 2.10"	Pneumatic Tire, Knobby	Most	V	163-186	Disc.
26" x 2.125"	Tube	Most		163-187	Disc.

Our wheels are available in many configurations including Grey and black mags, pneumatic and solid black or Grey tires, varying hub widths (be sure to consider your axle length when determining the hub size you need), multiple numbers of spokes, many different handrim styles and different bearing inside diameters.

**20" x 1-3/8" Black Mag**, Pneumatic Tire with 3/4" Powder Coated Handrim. Hub width measured Outside of Bearing to Outside of Bearing is approximately 2-3/8". Has flush outer bearing.

**Bearing I.D.** 7/16" 168-211 \$98.57 ea.

**Everest & Jennings,  
Theradyne, Quickie,  
Invacare & Others**

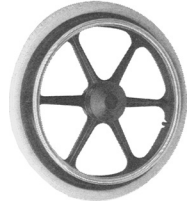

**20" x 1-3/8" Black Mag**, Pneumatic Tire with 3/4" Stainless Steel Handrim. Hub width measured Outside of Bearing to Outside of Bearing is approximately 2-3/8". Has recessed outer bearing.

**Bearing I.D.** 1/2" with 7/16" Reducer 168-311 \$101.55 ea.

**Invacare & Quickie**

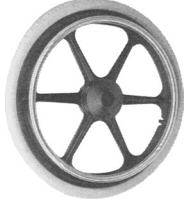

**22" x 1-3/8" 8 Spoke Black Mag**, Full Profile Poly Tire with 3/4" Aluminum Powder Coated Handrim.

Has flush outer bearing and fits most **Invacare, E&J, Theradyne and Quickie** chairs.

**Bearing I.D.** 7/16" 168-511 **Disc.**

Hub width measured Outside of Bearing to Outside of Bearing is approximately 2-5/8"

1/2" 168-512 **\$129.93 ea.**

Hub width measured Outside of Bearing to Outside of Bearing is approximately 2-1/16"

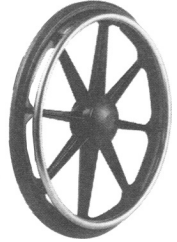

**24" x 1" Alloy Spoke Rim**, Solid Grey Tire with 5/8" Chrome Handrim. Has flush outer bearing. 2 1/2" Hub width.

**Bearing I.D.** 7/16" 160-111 \$54.29 ea.

5/8" 160-112 \$58.45 ea.

1/2" 160-113 \$72.73 ea.

**Everest & Jennings  
Theradyne, Quickie,  
Invacare & Others**



**24" x 1" 9 Spoke Black Mag**, Solid Urethane Tire with 3/4" Plastic Handrim. Hub width measured Outside of Bearing to Outside of Bearing is approximately 2-5/8". Has flush outer bearing.

**Bearing I.D.** 7/16" 160-511 \$85.71 ea.

5/8" 160-512 \$91.43 ea.

1/2" 160-513 \$91.43 ea.

**Everest & Jennings  
Theradyne, Quickie  
& Others**



## Black Mag



**24" x 1" 8 Spoke Black Mag**, Solid Grey Urethane Tire with 3/4" Handrim. Hub width measured Outside of Bearing to Outside of Bearing is approximately 2-5/8". Has flush outer bearing.

**Everest & Jennings  
Theradyne, Quickie  
& Others**

<b>Bearing I.D.</b>	7/16"	160-411	Disc.
	5/8"	160-412	Disc.
	1/2"	160-413	Disc.
	12mm x 32mm	160-414	Disc.



**24" x 1" 8 Spoke Black Mag**, Solid Black Urethane Tire with 3/4" Chrome Handrim. Hub width measured Outside of Bearing to Outside of Bearing is approximately 2-5/8". Has flush outer bearing.

**Everest & Jennings  
Theradyne, Quickie,  
Invacare & Others**

<b>Bearing I.D.</b>	7/16"	160-811	Disc.
	5/8"	160-812	Disc.
	1/2"	160-813	Disc.



**24" x 1" 9 Spoke Black Mag**, Solid Urethane Tire with 3/4" Chrome Handrim. Hub width measured Outside of Bearing to Outside of Bearing is approximately 2-1/4". Has recessed outer bearing.

**New Invacare Chairs  
Drive Chairs, Cruiser and  
Silver Sport**

<b>Bearing I.D.</b>	7/16"	168-611	\$92.16 ea.	Black Tire
	5/8"	168-612	\$97.10 ea.	Black Tire
	1/2"	168-613	\$97.88 ea.	Black Tire
				Drive Rear Wheel Assembly, Black Handrim, Hub Width 2-1/4"
	35 mm	160-114	\$54.40	Black Tire



**24" x 1-1/4" 8 Spoke Black Mag**, Grey Urethane Full Profile Treaded Tire with 3/4" Chrome Handrim. Hub width measured Outside of Bearing to Outside of Bearing is approximately 2-5/8". Has flush outer bearing.

<b>Bearing I.D.</b>	7/16"	160-607	\$63.16 ea.	Black Mag
	5/8"	160-608	Disc.	Black Mag
	1/2"	160-609	Disc.	Black Mag

## Grey Mag



**24" x 1" 8 Spoke Grey Mag**, Solid Dark Grey Urethane Tire with 3/4" Chrome Handrim. Hub width measured Outside of Bearing to Outside of Bearing is approximately 2-5/8". Has flush outer bearing.

**Everest & Jennings  
Theradyne, Quickie,  
Invacare & Others**

<b>Bearing I.D.</b>	7/16"	160-211	\$98.20 ea.
	5/8"	160-212	\$94.64 ea.
	1/2"	160-213	\$107.85 ea.

## Grey Mag Heavy Duty

**24" x 1" 8 Spoke Grey Mag**, Solid Grey Urethane Tire with 3/4" Chrome Handrim. Hub width measured Outside of Bearing to Outside of Bearing is approximately 2-5/8". Has flush outer bearing.

Bearing I.D. 5/8" 160-415 \$88.37 ea.

**Everest & Jennings**



## Pneumatic Tires

**24" x 1-3/8" 8 Spoke Grey Mag**, Grey Pneumatic Tire with 3/4" Chrome Handrim. Hub width measured Outside of Bearing to Outside of Bearing is approximately 2-5/8". Has flush outer bearing.

Bearing I.D. 7/16" 160-911 \$99.51 ea.  
5/8" 160-912 \$103.36 ea.  
1/2" 160-913 \$116.57 ea.

**Everest & Jennings  
Theradyne, Quickie,  
Invacare & Others**



## One Arm Drives

For ordering one arm drives call toll free **800-328-5343** with the following information:

**Make of Chair**  
**Model of Chair**  
**Serial Number**

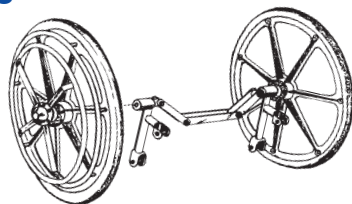

## MRI Non-Magnetic Rear Wheel, Complete Assembly

### Rear Wheel for 18" to 20" Wide Standard

MRI Wheelchair with 7/16" Bearings

Includes Wheel, Bearings

160-950 \$372.35 ea.



### Rear Wheel for 22" to 24" Wide Standard

MRI Wheelchair with 5/8" Bearings

Includes Wheel, Bearings

160-951 \$372.35 ea.



### Rear Wheel for 24" to 26" Wide Heavy Duty

MRI Wheelchair with 5/8" Bearings

Includes Wheel, Ceramic Bearings

160-952 Disc.



All Hub Widths are approximate and measure outside of bearing to outside of bearing.

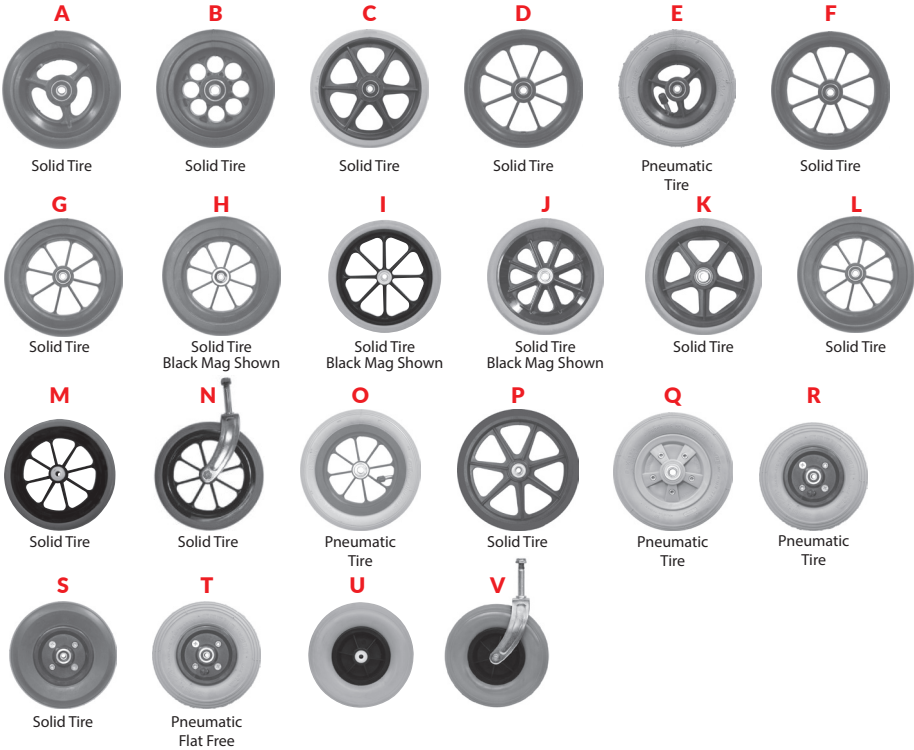

Size	Description	Bearing   Hub Size	Fig.	Part#	Price
5" x 1"	3 Spoke Black Mag, Black Urethane Tire	5/16"   1"	<b>A</b>	161-600	\$40.74 ea.
5" x 1"	8 Spoke Black Mag, Black Urethane Tire	5/16"   1-1/2"	<b>B</b>	161-608	Disc.
5" x 1"	8 Spoke Black Mag, Black Urethane Tire	5/16"   1-3/4"	<b>B</b>	161-601	Disc.
6" x 1"	6 Spoke Black Mag, Black Rubber Tire	5/16"   1"	<b>C</b>	161-616	\$32.57 ea.
6" x 1"	8 Spoke Black Mag, Grey Urethane Tire	5/16"   1-1/2"	<b>D</b>	161-617	\$29.29 ea.
6" x 1"	8 Spoke Black Mag, Grey Urethane Tire	7/16"   1-3/4"	<b>D</b>	161-609	\$39.64 ea.
6" x 1"	8 Spoke Black Mag, Grey Urethane Tire	5/16"   1-3/4"	<b>D</b>	161-602	\$28.29 ea.
6-1/4"	3 Spoke Black Mag, Pneumatic Tire	5/16"   1"	<b>E</b>	161-462	\$55.58 ea.
6-1/4"	8 Spoke Black Mag, Black Urethane Tire	5/16"   1-1/2"	<b>G</b>	161-618	\$26.68 ea.
6-1/4"	8 Spoke Black Mag, Black Urethane Tire	7/16"   1-1/2"	<b>F</b>	161-610	\$28.33 ea.
6-1/4"	8 Spoke Black Mag, Black Urethane Tire	5/16"   1-1/2"	<b>F</b>	161-603	\$26.68 ea.
7" x 1"	8 Spoke Black Mag, Black Urethane Tire	5/16"   1-1/2"	<b>G</b>	161-619	\$36.63 ea.
7" x 1"	8 Spoke Black Mag, Black Urethane Tire	5/16"   1-1/2"	<b>G</b>	161-604	\$40.76 ea.
7-1/2" x 1"	8 Spoke Black Mag, Black Urethane Tire	7/16"   2-3/8"	<b>H</b>	161-612	\$36.63 ea.
8" x 1"	7 Spoke (Black Mag), Grey Rubber Tire	5/16"   2-5/8"	<b>I</b>	161-412	\$20.60 ea.
8" x 1"	8 Spoke (Grey Mag), Grey Rubber Tire	7/16"   2-3/8"	<b>J</b>	161-211	\$20.84 ea.
8" x 1"	8 Spoke (Black Mag), Grey Rubber Tire	7/16"   2-3/8"	<b>J</b>	161-411	\$21.02 ea.
8" x 1"	8 Spoke (Black Mag), Grey Rubber Tire	1/4"   2-3/8"	<b>J</b>	161-413	Disc.
8" x 1"	8 Spoke (Grey Mag), Grey Rubber Tire	1/4"   2-3/8"	<b>J</b>	161-213	Disc.
8" x 1"	5 Spoke HD Grey Mag, Grey Rubber Tire	7/16"   2-3/8"	<b>K</b>	161-311	\$33.15 ea.
8" x 1"	5 Spoke HD Black Mag, Grey Rubber Tire	7/16"   2-3/8"	<b>K</b>	161-511	\$33.80 ea.
8" x 1"	8 Spoke Black Mag, Grey Rubber Tire	5/16" Precision   1-1/2"	<b>L</b>	161-621	Disc.
8" x 1"	8 Spoke Black Mag, Grey Rubber Tire	7/16" Flange   1-3/4"	<b>L</b>	161-613	\$35.47 ea.
8" x 1"	8 Spoke Black Mag, Grey Rubber Tire	5/16" Flange   1-3/4"	<b>L</b>	161-606	\$28.53 ea.
8" x 1"	8 Spoke Black Mag, Grey Rubber Tire	8mm Flange   56mm	<b>L</b>	161-414	\$11.44 ea.

## See Page 35 for Hub Patterns

Size	Description	Bearing   Hub Size	Fig.	Part#	Price
8" x 1"	MRI Non-Magnetic 18" to 24" Wheelchair	N/A	<b>M</b>	161-640	\$55.84 ea.
8" x 1"	MRI Non-Magnetic 18" to 24" Wheelchair	N/A	<b>N</b>	161-641	\$175.47 ea.
8" x 1-1/4"	8 Spoke Black Mag, Grey Pneumatic Tire	7/16"   2-3/8"	<b>O</b>	161-471	\$40.37 ea.
8" x 1-1/4"	7 Spoke Black Mag, Black Urethane Tire	5/16"   1-3/4"	<b>P</b>	161-491	\$54.00 ea.
8" x 1-3/4"	2 Piece Grey Hub, Grey Pneumatic Tire	5/16"   2-1/2"	<b>Q</b>	161-222	\$83.39 ea.
8" x 2"	2 Piece Black Hub, Grey Pneumatic Tire	5/16"   2-1/2"	<b>R</b>	161-482	\$45.18 ea.
8" x 2"	2 Piece Black Hub, Grey Pneumatic Tire	7/16"   2-1/2"	<b>R</b>	161-481	\$52.11 ea.
8" x 2"	2 Piece Black Hub, Black Urethane Tire	5/16"   2-1/2"	<b>S</b>	161-607	\$45.51 ea.
8" x 2"	2 Piece Black Hub, Black Urethane Tire	7/16"   2-1/2"	<b>S</b>	161-614	\$52.44 ea.
8" x 2"	2 Piece Black Hub, Grey Flat Free Pneumatic Poly Foam Filled Tire	5/16"   2-1/2"	<b>T</b>	161-497	\$57.02 ea.
8" x 2"	MRI Non-Magnetic 24" to 26" Wheelchair	N/A	<b>U</b>	161-642	\$69.80 ea.
8" x 2"	MRI Non-Magnetic 24" to 26" Wheelchair	N/A	<b>V</b>	161-643	\$185.04 ea.



**A E&J Chrome Fork** \*167-101 \$16.09 ea.

1/2" stem diameter - 2 1/2" stem length  
5" fork length - 2 9/16" fork opening  
accepts 5/16" axle - 1 Axle position

**E&J Black Fork** \*167-102 \$12.16 ea.

1/2" stem diameter - 2 1/2" stem length  
5" fork length - 2 9/16" fork opening  
accepts 5/16" axle - 1 Axle position

**F Drive Fork** 167-209 Disc.

12mm stem diameter - 2 9/16" stem length  
5 1/4" fork length - 2 5/8" fork opening  
accepts 8mm axle - 1 Axle position  
Commonly Fits Go-Kart, Navajo & Transport Chairs

**E Black Aluminum Fork** 167-207 \$66.76 ea.

1/2" stem diameter - 2 3/4" stem length  
7 1/2" fork length - 2 1/2" fork opening  
accepts 5/16" axle - 3 axle positions  
Commonly Fits Invacare Tracer SX5

**Black Aluminum Fork** 167-500 \$21.02 ea.

1/2" stem diameter - 2 7/16" stem length  
6" fork length - 2 3/8" fork opening  
accepts 8mm axle - 3 axle positions  
Commonly Fits Wheelchairs with 8 mm Axles

**Black Steel Fork** 167-208 \$43.87 ea.

1/2" stem diameter - 2 3/4" stem length  
7 1/2" fork length - 2 1/2" fork opening  
accepts 7/16" axle - 3 axle positions  
Commonly Fits Invacare Tracer EX2

**H Drive Fork** 167-211 Disc.

13mm stem diameter - 2 1/2" stem length  
7" fork length - 1 11/16" fork opening  
accepts 8mm axle - 4 axle positions  
Black Aluminum - Fits Cirrus IV Only

**I Drive Fork** 167-212 \$25.00 ea.

13mm stem diameter - 2 7/16" stem length  
7 1/4" fork length - 2 7/16" fork opening  
accepts 11mm axle - 3 axle positions  
Black Aluminum - Fits Cruiser and Silver Sport

**J MRI Non-Magnetic Fork**

167-520 \$106.41 ea.  
Front Fork with Nut,  
for Standard and Heavy Duty  
MRI Wheelchairs

### Axle Spacers



- 166-320 5/16" I.D. x 1/16" Long \$3.56 pk.
- 166-322 5/16" I.D. x 3/8" Long \$12.46 pk.
- 166-323 7/16" I.D. x 1/16" Long \$10.39 pk.
- 166-334 1/2" I.D. x 3/4" Long Disc.

All spacers come in a package of 4.



**Invacare Complete** \$10.56 ea.

Left 143-110  
Right 143-120

**Spring Only** \$2.12 pr.

Pair 143-137

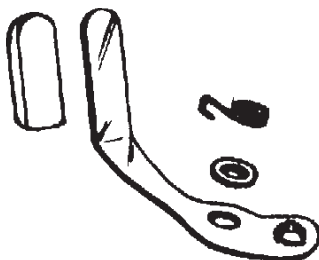

**Colson**

Left 143-310  
Right 143-320

**Spring Only**

Left 143-332  
Right 143-333

### Everest & Jennings



**Complete** \$5.97 ea.

Left 143-510  
Right 143-520

**Spring Only** Disc.

Left 143-530  
Right 143-531



143-503 \$11.80 ea.



143-501 Disc.

## Legrest Release Levers

### Everest & Jennings



**Release Lever**  
144-500 \$41.09 ea.



**Adjustment Rod**  
144-501 \$12.30 ea.

### Invacare



**Complete Set**  
144-130 Disc.

### Theradyne



**Release Lever** \$30.67 ea.  
Left 144-210  
Right 144-220

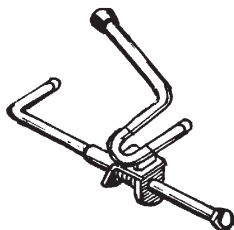

**Release Lever** Disc.  
Left Disc.  
Right, Limited Availability 144-221

### Gendron

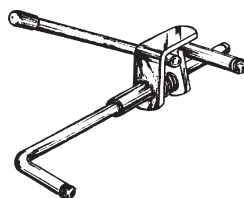

**Release Lever** \$46.93  
Left 144-411  
Right 144-421

# Universal Calf Pads and Padded Covers

## Padded Calf Pad Covers

Turn your plastic calf pad into a padded calf pad with this cover.

146-2CL \$7.18 ea.

Available in all colors below, except Mauve & Jade.

## Plastic Calf Pads

145-1CL \$15.60 ea.

Available in Blue, Grey, Black or Brown

## Padded Calf Pads

146-3CL Black Base \$17.90 ea.

Available in all colors below.

### Fits:

Invacare  
Everest & Jennings  
Smith & Davis  
Lumex



**Colors for Padded Calf Pads Above:** 67 Dark Blue, 68 Royal Blue, 83 Nutmeg, 82 Camel, 23 Mauve, 27 Burgundy, 54 Cactus, 57 Jade, 96 Beige, 46 Black or 44 Grey **Color page 69**

## Invacare Calf Pad Assembly

Fig.	Part #	Description	Price
	146-2CL	Calf Pad Cover Specify Color Above	\$7.18 ea.
B	164-480	Bolt	\$1.66 ea.
C	145-1CL	Calf Pad, Plastic	\$15.60 ea.
D	147-102	Pad Plate	\$5.89 ea.
	147-103	Swivel Bracket	\$26.23 ea.
F	147-104	Spring	\$12.39 ea.
G	147-105	Bushing	\$13.76 ea.
H	164-506	Nut	\$.26 ea.
I	147-106	Mounting Bracket Black	Disc.
J	147-101	Spacer	\$11.94 ea.

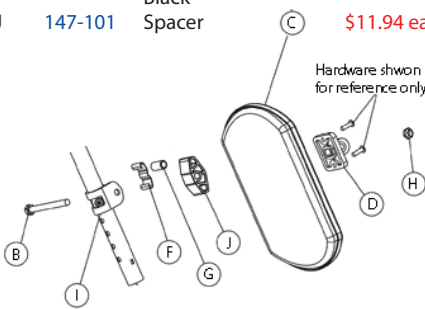

## Theradyne or American Calf Pad Assembly

Fig.	Part #	Description	Price
A	164-507	Nuts	\$.69 ea.
B	147-202	Carriage Bolt	\$.26 ea.
C	147-203	Swivel Bracket	Disc.
D	147-204	Grey Vibro	\$1.06 ea.
E	147-205	Calf Pad Plate	Disc.
F	145-246	Calf Pad, Plastic	Disc.
	146-2CL	Calf Pad Cover Specify Color Above	\$7.18 ea.

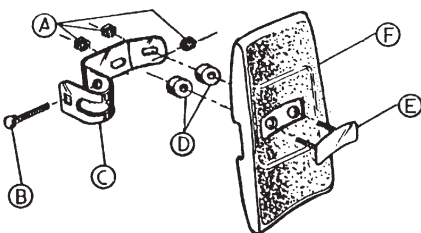

## MRI Non-Magnetic Calf Pads

Padded Calf Pad for MRI Legrests  
Hole Spacing: 2"

### Choose Color

146-6CL \$52.35 ea.

Available in Burgundy (27) or Green (50)



## Everest & Jennings Calf Pad Assembly

Fig.	Part #	Description	Price
A	146-1CL	Padded Calf Pad Specify Color Above	Disc.
A	145-1CL	Plastic Calf Pad Blue, Grey or Cocoa	\$15.60 ea.
B	147-501	Plate w/Spring	\$4.22 ea.
C	147-502	Swivel Bracket	\$8.54 ea.
F	147-508	Spring Only	\$1.18 ea.

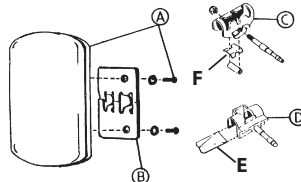

## Gendron Calf Pad Assembly

Fig.	Part #	Description	Price
A	146-7CL	Calf Pad Padded Specify color below	\$22.73 ea.
B	147-413	Screw	\$.26 ea.
C	147-414	Lock Washer	\$.26 ea.
D	147-415	Pad Plate	\$27.73 ea.
E	147-416	Bushing	\$2.78 ea.
F	147-417	Swivel Bracket	\$16.41 ea.
G	147-418	Bushing	\$1.08 ea.
H	147-419	Lock Nut	\$.26 ea.

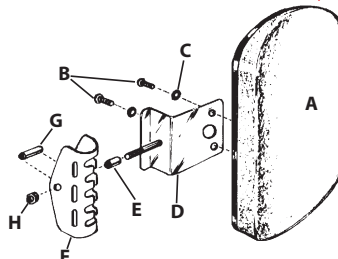



## Footplates

### Standard Footplate For 7/8" tubing

- 148-100 Aluminum \$11.52 ea.
- 148-116 Plastic \$11.21 ea.

### MRI Non-Magnetic Footplates

- 18" to 24" MRI Standard Chair
- 148-122 \$61.78 ea.
- 24" to 26" MRI Heavy Duty Chair
- 148-121 \$93.06 ea.

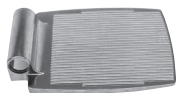

### Override Footplate Black, 8-1/2"L x 7-3/4"W For 7/8" tubing

- 148-101 Left side \$91.09 ea.
- 148-102 Right Side \$91.09 ea.

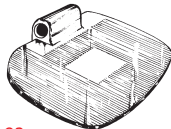

### Black Footplate For Drive Wheelchairs

- 148-120 Plastic \$22.91 ea.

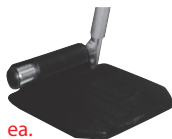

- Tube Cap** \$1.33 ea.
- Grey 125-105
- Brown 125-100
- Black 125-102



- MRI Non-Magnetic  
Roller Bumper,**  
for HD Chairs only  
Fits 3/4" I.D. tubing
- 149-151 \$23.45 ea.



- MRI Non-Magnetic  
Screw for MRI Foot /  
Legrest Rubber Bumper,**  
Fits all MRI Chairs
- 149-153 \$9.99 ea.



- Roller Bumper**  
149-103 \$4.40 ea.



- Bumper**  
149-119 Black  
\$.96 ea.



- Black Rubber
- Legrest Release  
Levers Cap**  
125-103 \$1.98 ea.

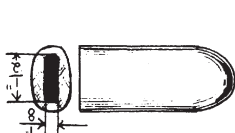

- Legrest Grip**  
Rubber  
1/2" x 1/8" Grey  
120-105 \$2.19 ea.
- 1/2" x 1/8" Black  
120-112 \$2.67 ea.

## Extension Tube with Draw Bolt



- 148-111 \$12.32 ea.



- Everest & Jennings Footrest &  
Legrest Draw Bolt**  
Adult 148-103 \$4.40 ea.

## Standard Footplate with Extension Tube & Draw Bolt

- With Out Heel Loops** \$22.88 ea.
- Left 148-105
- Right 148-106
- With Heel Loops** \$23.62 ea.
- Left 148-107
- Right 148-108

### MRI Non-Magnetic Draw-Bolt Style Replacement Extension Tube Assembly and Footrest

- 18" MRI Fixed Chair, Choose Side
- 148-150-X Disc.

- Clamp-On Style**  
18" MRI Fixed Chair, Choose Side
- 148-151-X \$117.31 ea.



## Footrest Hangers



- E & J Camlock** \$23.94 ea.
- Left 148-112
- Right 148-113
- Invacare Camlock** \$28.39 ea.
- Left 148-114
- Right 148-115



- Foot & Legrest Clamp**  
3/4"-7/8" 149-107 \$3.32 ea.
- 7/8"-1" 149-120 \$4.71 ea.

## Damper



- Grey Rubber  
149-100 \$1.11 ea.



- MRI Tension  
"O" Ring, Fits  
all MRI Chairs**
- 149-152 \$12.41 ea.

## Spring Steel



- 149-112  
\$2.67 ea.

## Spring Steel

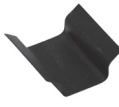

- E&J  
149-110  
\$1.49 ea.

## Spring Steel



- Invacare  
149-108  
\$1.31 ea.

## Spring Steel



- Gendron  
149-109  
\$2.78 ea.

## Determine Your Footrest or Legrest Type

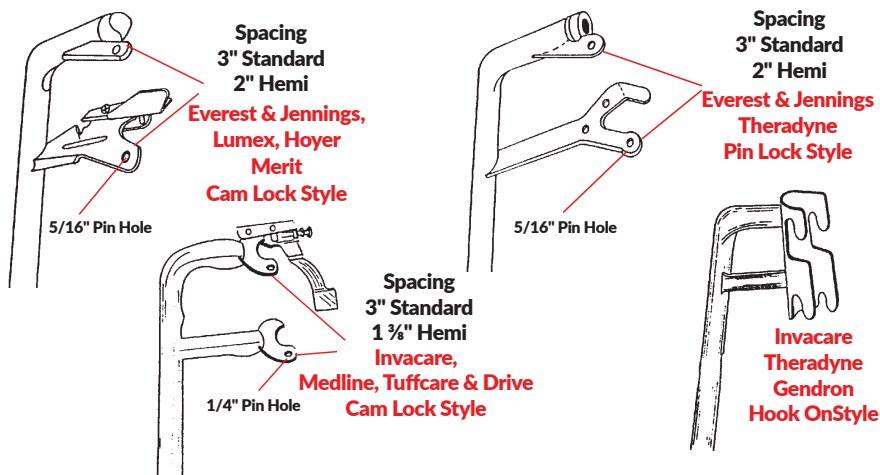

## Front Rigging Locking Kits

Prevent removal and possible loss of your expensive swingaway footrests or legrests. Threadless end caps push onto the bottom pin and make it difficult to remove your front rigging. Clamp style, clamps onto the bottom pin by tightening the allen head screw, allen wrench included in this set.



**Threadless End Caps**

149-104	1/4"	\$1.28 ea.
149-105	5/16"	\$1.28 ea.
149-106	7/16"-1/2"	\$2.64 ea.



**Clamp Locks**

**MRI Non-Magnetic Locking Kit**

Clamp Locks 1/4"

149-154	\$35.17 pr.
---------	-------------

149-117	1/4"	\$8.93 pr.
149-118	5/16"	\$8.93 pr.

## Heel and Toe Loops



Econo Heel Loop	196-102	\$5.62 ea.
Heel Loop	196-100-CL	\$6.58 ea.
Padded Heel Loop	196-101-CL	\$8.59 ea.
Toe Loop	196-200-CL	\$7.37 ea.
Padded Toe Loop	196-201-CL	\$9.50 ea.

## MRI Non-Magnetic Heel Loops



18" to 24" Wide MRI Standard Chairs Universal Fit	196-130	\$72.65 ea.
24" to 26" Wide MRI Heavy Duty Chairs Choose Side, L or R	196-131-X	\$72.65 ea.



Right



Right

## MRI Non-Magnetic Heel Loop and Footplate

18" to 24" Wide MRI Standard Chairs Choose Side, L or R	196-132-X	Disc.
24" to 26" Wide MRI Heavy Duty Chairs Choose Side, L or R	196-133-X	\$97.01 ea.

## Footrest Pads

Specify color from page 69



Made with 1/2" foam. Attaches to footrests with velcro straps or metal hooks. Velcro style or hook on style are made for 18" wide chairs. Special sizes available upon request.



**Footrest Pad**

Velcro	191-1CL	\$37.69 ea.
Hooks	196-202-CL	\$37.84 ea.

## Invacare Cam-Lock Swingaway Detachable Footrests

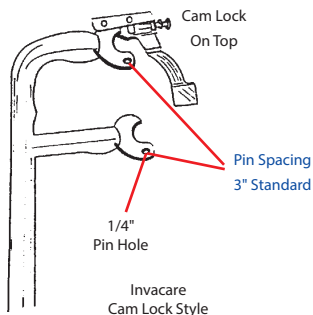

### Standard

**Sold in Pairs** Economy Black Plastic Footplates w/ Heel Loops  
140-202 \$38.87 pr.

**Sold by Side** Deluxe Silver Aluminum Footplates  
**Left** - 140-110-L \$43.24 ea.  
**Right** -140-110-R \$43.24 ea.

**Sold in Pairs** Deluxe Black Aluminum Footplates w/ Heel Loops  
140-200 \$39.64 pr.

To convert hook-on style chairs to accept swingaway footrests, see adapters on Page 39-40.

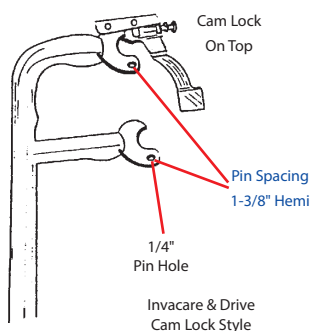

### Hemi

**Sold in Pairs** Economy Black Plastic Footplates w/ Heel Loops  
140-203 \$39.64 pr.

**Sold in Pairs** Deluxe Silver Aluminum Footplates  
140-204 \$70.73 pr.

**Sold in Pairs** Deluxe Black Aluminum Footplates w/ Heel Loops  
140-201 \$63.73 pr.

## Gendron Cam-Lock Swingaway Detachable Footrests

## Hook-On Detachable Footrests



Standard and Hemi  
140-630 Pair \$349.09 ea.



140-010 Left \$102.04 ea.  
140-020 Right \$102.04 ea.



**Do you have a hook-on style chair and want to convert it to detachable swingaway footrests?**

Adapters convert Hook-on style chairs to accept Gendron swingaway cam-lock footrests. These brackets will fit Invacare, Gendron and Theradyne hook-on style chairs. Only Gendron Footrests will fit the adapters.

142-410-L Left Disc.  
142-410-R Right Disc.

## MRI Non-Magnetic Footrests

### MRI Aluminum Footrests

Detachable Swing-Away with Heel Loops, Choose **Left or Right** for Aluminum Wheelchairs

140-700-X \$218.94 ea.



### MRI Non-Magnetic Footrests

Detachable Swing-Away with Heel Loops, Choose **Left or Right**

18" to 20" Wide Chairs, Standard  
140-701-X \$186.90 ea.  
22" to 24" Wide Chairs, Standard  
140-702-X \$299.06 ea.  
24" to 26" Wide Chairs, Heavy Duty  
140-703-X \$336.65 ea.



# O2 Concepts Oxlife Oxygen Concentrators

Patented EnergySmart® technology



## Oxlife Independence Oxygen Concentrator



**SKU: 207-001-BA**

**Price: \$2,105.26**

Oxlife Independence® Oxygen Concentrators take POC performance to the next level. With patented EnergySmart® technology, it boasts the longest battery life in class and delivers over three times the flow of the leading POC.

**Benefits:**

- Best battery life in class
- Continuous flow up to 3.0 LPM for safe sleep
- With DNA Technology, Oxlife Independence is the world's first smart POC

## Oxlife Freedom Portable Oxygen Concentrator



**SKU: 207-002**

**Price: \$1,375.00**

Oxlife Freedom® Portable Oxygen Concentrators deliver a smaller 5lb device built on the technology and reliability of the Independence. With patented Energy Smart Technology®, it boasts long battery life and delivers the same robust pulse oxygen dosage as the Independence.

**Benefits:**

- Large LCD screen with simple control display
- Smart Battery with long life and quick recharge life
- Pulse flow settings of 1 - 5



**Accessory Bag**

**SKU: 207-005**

**Price: \$39.22**



**Oxlife Protective Cover**

**SKU: 207-006**

**Price: \$122.95**



**Freedom Concentrator Battery**

**SKU: 207-004**

**Price: \$354.55**



**Freedom Carry Bag**

**SKU: 207-007**

**Price: \$78.43**



**Concentrator Inlet Filter**

**SKU: 207-008**

**Price: \$19.61**

# E&J, Lumex, Hoyer, Merit & New Theradyne Cam-Lock Swingaway Detachable Footrests

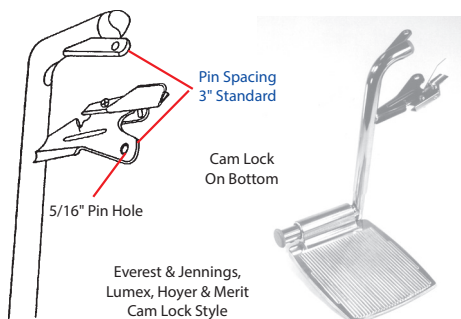

## Standard

**Sold per Side** **Economy** Standard Release Levers,  
Silver Aluminum Footplates  
140-510 Left **\$42.64 ea.**  
140-520 Right **\$39.02 ea.**

**Sold per Side** **Deluxe** Standard Release Levers,  
Silver Aluminum Footplates w/ Heel Loops  
140-512 Left **\$40.51 ea.**  
140-522 Right **\$40.51 ea.**

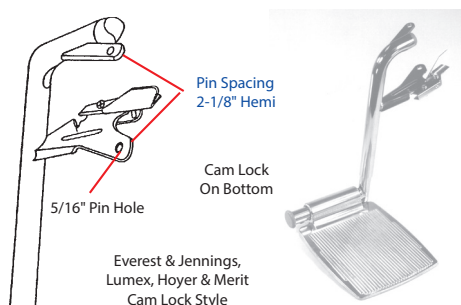

## Hemi

**Sold per Side** **Economy** Standard Release Levers,  
Silver Aluminum Footplates  
140-514 Left **\$38.51 ea.**  
140-524 Right **\$38.51 ea.**

**Sold per Side** **Deluxe** Standard Release Levers,  
Silver Aluminum Footplates w/ Heel Loops  
140-518 Left **\$40.51 ea.**  
140-528 Right **\$40.51 ea.**

# Pin Lock Swingaway Detachable Footrests

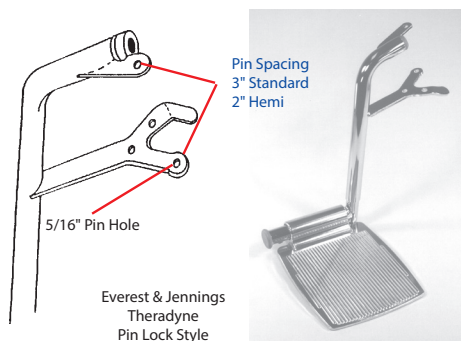

## Everest & Jennings

140-511	Standard Left	<b>\$44.25 ea.</b>
140-521	Standard Right	<b>\$44.25 ea.</b>
140-516	Hemi Left	<b>\$50.33 ea.</b>
140-526	Hemi Right	<b>\$50.33 ea.</b>

## Old Theradyne

140-511	Standard Left	<b>\$44.25 ea.</b>
140-521	Standard Right	<b>\$44.25 ea.</b>
140-515	Hemi Left	<b>Disc.</b>
140-525	Hemi Right	<b>Disc.</b>

# MRI Non-Magnetic Legrests

## MRI Non-Magnetic Legrests

Detachable Swing-Away with  
Heel Loops and Calf Pads  
Choose Side (X): (L)Left or (R)Right  
Choose Color (CL): Burgundy -27 or Green - 50

18" to 24" Wide Chairs, Standard  
140-750-X-CL **Disc.**  
24" to 26" Wide Chairs, Heavy Duty  
140-751-X-CL **\$440.33 ea.**



Visit our New Online Store  
[www.CurtainTracking.com](http://www.CurtainTracking.com)

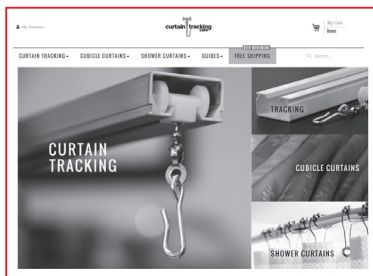

## Invacare Cam-Lock Swingaway Detachable Elevating Legrests

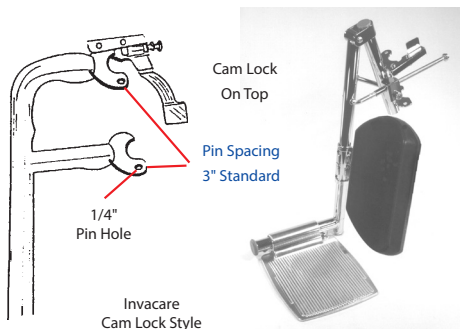

### Standard

**Sold in Pairs Economy** Black Padded Calf Pads, Black Plastic Footplates  
141-800-46 Pair **\$82.22 pr.**

**Sold per Side Deluxe** Padded Calf Pads, Silver Aluminum Footplates  
141-200-CL Left **\$80.49 ea.**  
141-300-CL Right **\$80.49 ea.**

**Sold in Pairs Economy** Padded Calf Pads, Black Aluminum Footplates  
141-804-46 Pair **\$96.86 pr.**

For padded calf pad cover order **146-2CL \$7.18 ea.**

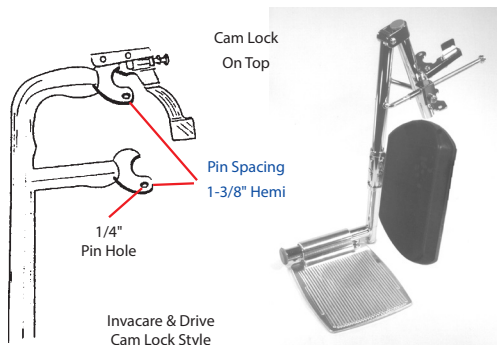

### Hemi

**Sold in Pairs Economy** Black Plastic Calf Pads, Black Plastic Footplates  
141-801-46 Pair **\$67.47 pr.**

**Sold per Side Deluxe** Padded Calf Pads, Silver Aluminum Footplates  
141-240-CL Left **\$78.27 ea.**  
141-340-CL Right **\$78.27 ea.**

**Sold in Pairs Economy** Black Padded Calf Pads, Black Plastic Footplates  
141-802-46 Pair **\$96.86 pr.**

For padded calf pad cover order **146-2CL \$7.18 ea.**



### Articulating Legrest (Invacare SmartLeg™)

**Hemi Pin Spacing 1-3/8\" Hemi**  
141-360-46 Pair **\$147.00 pr.**

**Black Calf Pad**  
An articulating legrest will lengthen the bar as the legrest is raised. This will provide enough length for the leg to extend and the foot will not push against the footplate.

## Gendron Cam-Lock Swingaway Detachable Elevating Legrests

**Features:** Padded Calf Pad and Silver Aluminum Footplates

**Standard or Hemi**  
141-400-CL Left **Disc.**  
141-500-CL Right **Disc.**

**Available colors:** Grey, Burgundy, Dk. Blue, Black and Brown

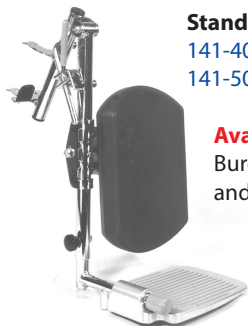

## Hook-On Detachable Elevating Legrests

### Invacare, Gendron & Theradyne

**Features:** Padded Calf Pad and Silver Aluminum Footplates

141-010-CL Left **Disc.**  
141-020-CL Right **Disc.**

**Available colors:** Grey, Burgundy, Dk. Blue, Brown and Black



# E & J, Lumex, Hoyer, Merit & New Theradyne Cam-Lock Swingaway Detachable Elevating Legrests

## Standard

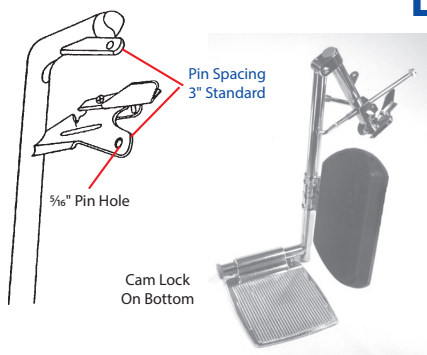

**Sold in Pairs** Padded Calf Pads,  
Silver Aluminum Footplates  
141-803-CL Pair **\$99.67 pr.**

**Sold in Pairs** Plastic Calf Pads,  
Silver Aluminum Footplates  
141-805-CL Pair **\$86.83 pr.**

For padded calf pad cover order: 146-2CL **\$7.18 ea.**

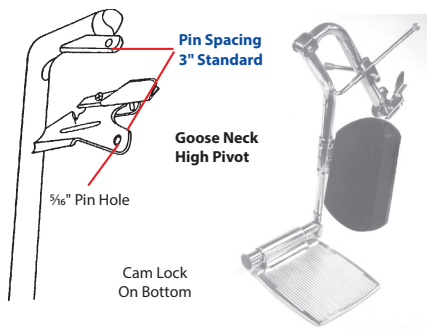

## High Pivot/Recliner

**Sold per Side Deluxe** Padded Calf Pads,  
Silver Aluminum Footplates  
141-640-CL Left **\$85.77 pr.**  
141-740-CL Right **\$85.77 pr.**

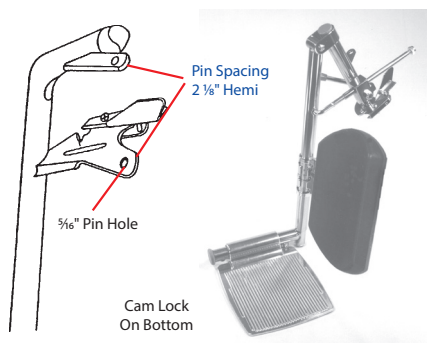

## Hemi

**Sold per Side Economy** Plastic Calf Pads,  
Silver Aluminum Footplates  
141-620-CL Left **\$67.06 pr.**  
141-720-CL Right **\$67.06 pr.**

**Sold per Side Deluxe** Padded Calf Pads,  
Silver Aluminum Footplates  
141-630-CL Left **\$68.73 pr.**  
141-730-CL Right **\$68.73 pr.**

For padded calf pad cover order: 146-2CL **\$7.18 ea.**

# Pin Lock Swingaway Detachable Elevating Legrests

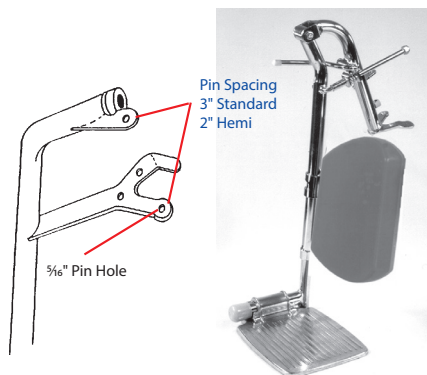

## Everest & Jennings

**Features:** Padded Calf Pads and Silver Aluminum Footplates

141-410-CL	Standard Left	<b>\$101.73 ea.</b>
141-510-CL	Standard Right	<b>\$101.73 ea.</b>
141-440-CL	Hemi Left	<b>\$101.73 ea.</b>
141-540-CL	Hemi Right	<b>\$101.73 ea.</b>

## Old Theradyne

**Features:** Padded Calf Pads and Silver Aluminum Footplates

141-410-CL	Standard Left	<b>\$101.73 ea.</b>
141-510-CL	Standard Right	<b>\$101.73 ea.</b>
141-430-46	Hemi Left	<b>Disc.</b>
141-530-46	Hemi Right	<b>Disc.</b>

For padded calf pad cover order: 146-2CL **\$7.18 ea.**

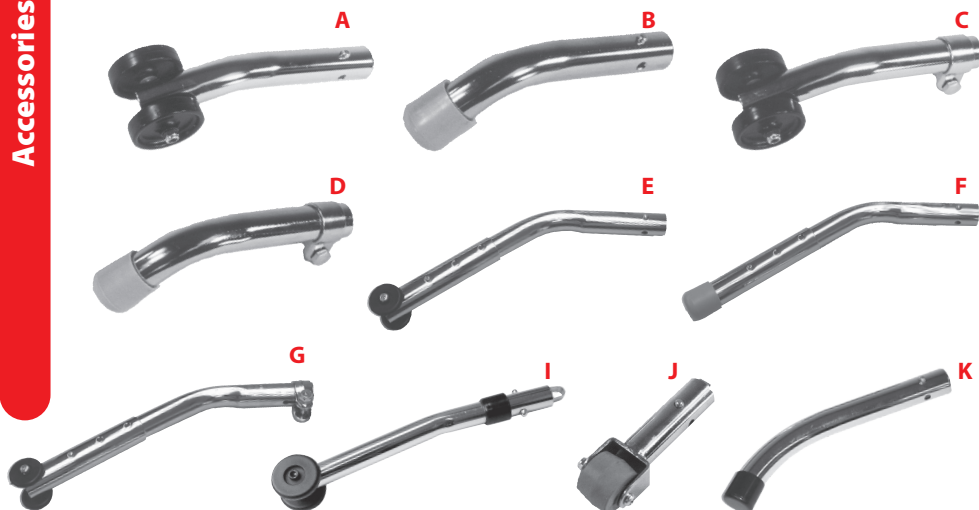

## Standard Rear Anti-Tippers

These anti-tippers fit standard frames for E&J, Theradyne, Tuffcare, Hoyer, Old Style Invacare, and others with a kick tube height of 3" to 5" from bottom of kick tube to floor. Fit on the outside of tubing.

### Push Button Anti-Tipper

- A Wheeled, fits over 7/8" O.D. Tubing  
193-124 \$42.07 a pair
- A Wheeled, fits over 1" O.D. Tubing  
193-122 \$42.07 a pair
- B Bumper, fits over 7/8" O.D. Tubing  
193-120 \$41.78 a pair
- B Bumper, fits over 1" O.D. Tubing  
193-121 \$41.23 a pair

### Clamp On Anti-Tipper

- C Wheeled, fits over 7/8" O.D. Tubing  
193-110 \$48.04 a pair
- C Wheeled, fits over 1" O.D. Tubing  
193-113 \$48.05 a pair
- D Bumper, fits over 7/8" O.D. Tubing  
193-111 \$46.36 a pair
- D Bumper, fits over 1" O.D. Tubing  
193-112 \$42.30 a pair

## Adjustable Height Rear Anti-Tippers

These anti-tippers fit standard frames for new style Invacare, Medline and others with a kick tube height of 6" to 10-1/2" from bottom of kick tube to floor. Fit on the outside of tubing.

### Push Button Anti-Tipper

- E Wheeled, fits over 7/8" O.D. Tubing  
193-140 \$57.54 a pair
- E Wheeled, fits over 1" O.D. Tubing  
193-141 \$57.54 a pair
- F Bumper, fits over 7/8" O.D. Tubing  
193-142 \$56.23 a pair
- F Bumper, fits over 1" O.D. Tubing  
193-143 \$56.20 a pair

### Clamp On Anti-Tipper

- G Wheel and Bumper, fits over 7/8" O.D. Tubing  
193-144 \$63.64 a pair
- G Wheel and Bumper, fits over 1" O.D. Tubing  
193-145 \$63.64 a pair

## Super-Hemi Rear Anti-Tippers

These anti-tippers fit most any standard super-hemi frames with 7/8" tubing. Fit on the outside of tubing.

### Push Button Anti-Tipper

- I Wheeled, 1" Drop  
193-118 \$42.81 a pair
- J Wheeled, No Drop  
193-123 \$36.55 a pair

## MRI Wheelchair Non-Magnetic Rear Anti-Tippers

These anti-tippers fit most any standard MRI wheelchairs, non-magnetic for use in MRI room. Kick tube height of 3" to 5" from bottom of kick tube to floor. Fit on the outside of tubing.

### Push Button Anti-Tipper

- K Bumper, fits over 7/8" O.D. Tubing  
193-170 \$65.18 a pair



## Wheelchair I.V. Poles and Oxygen Holders

### A I.V. Pole, 2 Hook

Fits most standard chairs, I.V. pole is adjustable

STD Chair	198-100	\$51.97 ea.
MRI Chair (non-magnetic)	198-110	\$196.35 ea.

### B I.V. Pole, 1 Hook

Fits most standard chairs, I.V. pole is adjustable

STD Chair	198-101	\$74.41 ea.
-----------	---------	-------------

### C Oxygen Tank Holder

Fits most standard chairs, oxygen holder is for D-E size cylinders

STD Chair Right Side Mount	198-200	\$63.00 ea.
STD Chair Left Side Mount	198-201	\$62.54 ea.
MRI Chair (non-magnetic) Right Side Mount	198-210	\$162.97 ea.

### D I.V. Pole and Oxygen Tank Holder

Fits most standard chairs, adjustable in height, oxygen holder is for D-E size cylinders

STD Chair	198-300	\$57.29 ea.
MRI Chair (non-magnetic)	198-310	\$264.96 ea.

### E O2 Tank Carrier for Rollators

Attaches conveniently to the frame of a 3- or 4-wheel rollator. Provides secure handling of a single D or E cylinder where a mobile oxygen unit is required. Fits most rollators

STD Rollators	250-193	Disc.
---------------	---------	-------

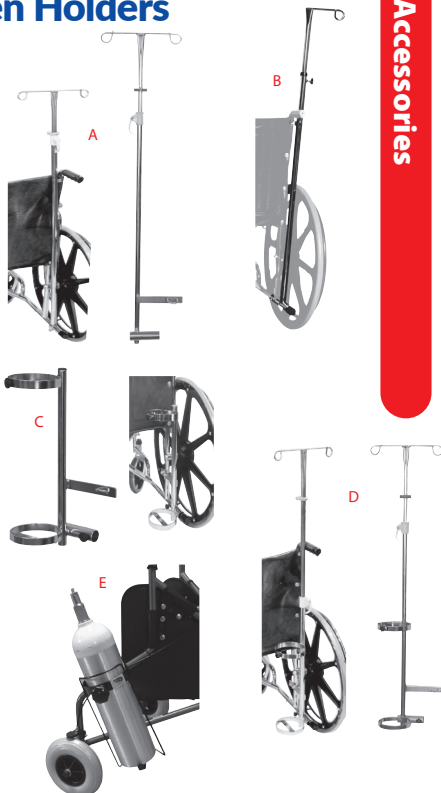

## Front Anti-Tippers

This product prevents patients from tipping forward on the wheelchair. Fits on 7/8" and 1" O.D. tubing.

### Front Anti-Tippers

7/8" O.D. Tubing	193-102	\$24.79 ea.
1" O.D. Tubing	193-119	\$21.65 ea.



## Adjustable Front Anti-tippers

### Features:

Five height adjustments; fits full height to low hemi chairs.  
Fits both 7/8" and 1" frame diameter.  
Made from durable powder coated steel tubing and heavy gauge chrome plated steel.  
2" easy gliding wheels.  
Mounting hardware and easy to follow installation instructions included.

Anti-Tippers	193-156	\$76.47 a pair
--------------	---------	----------------



## Light & Go Mobility Light

### Features:

Patented motion and light-activated technology  
For hands-free use with wheelchairs, Walkers and Rollators  
Comes with protective rubber boot  
3 bright, long-life LEDs for enhanced visibility  
Runs on 2 standard AAA batteries (included)  
Easy-to-use clamp with foam padding for secure grip

Light & Go Mobility Light	240-305	Disc.
---------------------------	---------	-------



## Rear Anti-Tippers for use with Invacare Veranda

These rear anti-tippers are made specifically for use with the Invacare Veranda Wheelchair. They connect to the rear tubes of the wheelchair. These anti-tippers only come in the color black.

Rear Anti-Tipper 193-100 **\$31.12 a pair**



## Universal Fit Adjustable Height Rear Anti-Tipper

Made of strong bar stock, this anti-tipper will help you streamline your inventory. It's the only anti-tipper that you need to stock. New quick adjust feature allows the anti-tipper to be positioned properly without the use of tools. Flat black powder coat finish or Chrome finish available. 2 Inch Durable Plastic Wheel.

Black Anti-Tipper 193-171 **Disc.**  
 Chrome Anti-Tipper 193-172 **\$35.69 a pair**

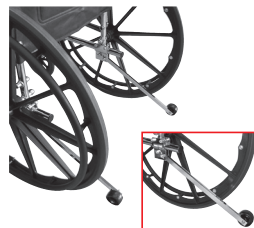

## Adjustable Anti-Theft Bar

This device prevents the wheelchair from folding up. It works on wheelchairs from 16" to 24" wide.

**Anti-Theft Bar**  
 16" to 20" Wide 199-109 **\$25.14 ea.**  
 22" to 24" Wide 199-110 **\$28.25 ea.**



## Over Head Anti-Theft Bar

This over head device prevents the wheelchair from folding up. Fits wheelchairs 18" to 26" wide. Other sizes available upon request. No available in non-magnetic for MRI wheelchairs.

<b>STD Wheelchairs</b>	<b>MRI Wheelchair (non-magnetic)</b>
18" Wide 199-111 <b>\$84.82 ea.</b>	18" Wide 199-130 <b>Disc.</b>
20" Wide 199-115 <b>\$98.36 ea.</b>	20" Wide 199-132 <b>\$307.40 ea.</b>
22" Wide 199-118 <b>\$98.36 ea.</b>	22" Wide 199-131 <b>\$307.40 ea.</b>
24" Wide 199-116 <b>\$98.36 ea.</b>	24" Wide 199-133 <b>\$307.40 ea.</b>
26" Wide 199-117 <b>\$98.36 ea.</b>	



## Universal Wheelchair Brake Extensions

### Features:

Available in three lengths.  
 Available in two slot sizes.  
 Available with or without elastic cord.

### Elastic Cord

The elastic cord connects the extension to the brake. This helps to hold the extension on the brake.



<b>A Without Elastic Cord</b>	<b>\$6.19 ea.</b>
6" Extension with 1/8" Slot Size	154-102
6" Extension with 3/16" Slot Size	154-105
8" Extension with 1/8" Slot Size	154-101
8" Extension with 3/16" Slot Size	154-104
10" Extension with 1/8" Slot Size	154-100
10" Extension with 3/16" Slot Size	154-103
<b>B With Elastic Cord</b>	<b>\$10.59 ea.</b>
6" Extension with 1/8" Slot Size	154-108
6" Extension with 3/16" Slot Size	154-111
8" Extension with 1/8" Slot Size	154-107
8" Extension with 3/16" Slot Size	154-110
10" Extension with 1/8" Slot Size	154-106
10" Extension with 3/16" Slot Size	154-109

## Full Size Wheelchair Trays

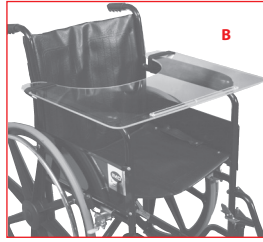

One size fits all adult and junior wheelchairs. Velcro straps fasten tray securely to any style arm. Three styles to choose from.

### Trays

A Wood (24"x20"x1½")	195-100	\$54.63 ea.
B Acrylic (23"x19"x¼")	195-103	\$87.20 ea.
C Padded (24"x20"x1")	195-2CL*	\$101.53 ea.

## Wheelchair Headrest Extension

Made with Naugahyde, 1" foam and chrome plated mounting hardware. Mounts beneath top two upholstery screws on the back of most wheelchairs. Adjustable height.



<b>Headrest Extension</b>	\$77.39 ea.
Narrow Adult 16"	197-1CL
Standard Adult 18"	197-2CL
Flare Back 20"	197-3CL

\*Specify color from page 69\*

## Lateral Supports

Made with Naugahyde, 1" foam and ½" wood with 1" web and velcro straps to attach to chair. **Specify left or right when sitting in chair.** Custom sizes available upon request on all upholstered items.



<b>Lateral Support</b>	\$100.26 ea.
Left Side	194-3CL-SD
Right Side	194-3CL-SD

\*Specify color from page 69\*

## Arm Trough

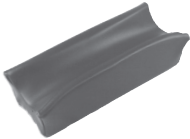

Available in two standard lengths.  
Desk Arms 9"x5"x5".  
Full Arms 12"x5"x5".  
Special sizes available upon request.

<b>Armrest Pads</b>	\$69.97 ea.
Full Arm	194-8CL
Desk Arm	194-7CL

\*Specify color from page 69\*

## Wrap Around Armrest Pads



Made with Naugahyde. 1½" foam.  
2" velcro, and ties for attaching to arms.  
Aids in positioning of the patient.

<b>Armrest Pads</b>	\$56.65 ea.
Full Arm	194-5CL
Desk Arm	194-6CL

\*Specify color from page 69\*

## Lumbar Pad



Made with Naugahyde.  
15" long x 3" tall x 2" deep foam.  
1" web straps with plastic buckle.

703-205-CL	\$46.42 ea.
------------	-------------

\*Specify color from page 69\*

## Headrest Pad



Made with Naugahyde.  
15½" wide x 6" deep x 5" Tall.  
1½" web straps and velcro for attaching to chair.

Headrest	202-4CL	\$74.01 ea.
----------	---------	-------------

\*Specify color from page 69\*

## Padded Footplates



Made with 1" foam.  
Attaches with velcro to footrests.  
Fits standard footplates.  
Special sizes available upon request.

Padded Footplates	196-4CL	\$35.99 pr.
-------------------	---------	-------------

\*Specify color from page 69\*

## Heel and Toe Loops



### Attaching Hardware Included

Econo Heel Loop	196-102	\$5.62
Heel Loop	196-100-CL	\$6.58
Padded Heel Loop	196-101-CL	\$8.59
Toe Loop	196-200-CL	\$7.37
Padded Toe Loop	196-201-CL	\$9.50

\*Specify color from page 69\*

## Padded Calf and Foot Board

Made with 1" foam and ½" wood. Attaches to footrests with velcro and buckles. Fits standard 18" wide chairs. Special sizes available upon request.

Calf and Foot Board 196-5CL \$117.71 ea.

**\*Specify color from page 69\***



## Footrest Pads

Made with ½" foam. Attaches to footrests with velcro straps or metal hooks. Velcro style or hook on style are made for 18" wide chairs. Special sizes available upon request.

### Footrest Pad

Velcro 191-1CL \$37.69 ea.  
Hooks 196-202-CL \$37.84 ea.

**\*Specify color from page 69\***



## H-Strap Belt

Made with long wearing web material. Prevents feet from falling behind footplates and causing serious pain or injury to patient. Special sizes available upon request.

16-18" Wide Chairs 196-300-CL \$23.29 ea.  
20" Wide Chairs 196-301-CL \$23.29 ea.  
22" Chairs 196-302-CL \$23.29 ea.

**\*Specify color from page 69\***

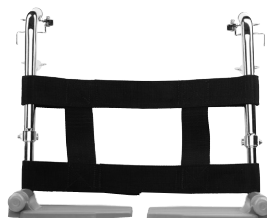

## Wheelchair and Walker Pouches

### Features:

Made with Naugahyde.  
Durable and inexpensive.  
Great for carrying personal items or patient charts.

### Wheelchair and Walker Pouches

A Deluxe Wheelchair Pouch 192-2CL \$27.53 ea.  
B Econo Wheelchair Pouch 192-1CL \$21.16 ea.  
C Walker Pouch 249-1CL \$19.83 ea.

**\*Specify color from page 69\***



## Drainage Bag Covers and Holder

Holder mounts beneath two upholstery screws on back of wheelchair. Adjustable arm for folding chair.

### Drainage Bag Covers and Holder

A Cover and Holder 194-1CL \$18.99 ea.  
B Bard Bag Cover (Bard Bag #802001) 194-2CL \$16.85 ea.

**\*Specify color from page 69\***

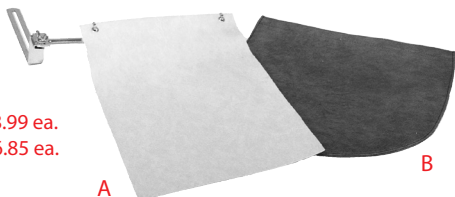

## Standard Cushion

The standard cushion adds comfort to any chair, choose between 2" or 3" thickness. Foam is fire retardant. Choose your covering. This cushion is universal to fit most standard adult 18" and narrow adult 16" wheelchairs. The cushion comes with ties for securing to back of chair.

### Standard Cushion

16"x16"x2" 192-4CL \$46.85 ea. 16"x16"x3" 192-8CL \$52.54 ea.  
18"x16"x2" 192-3CL \$46.85 ea. 18"x16"x3" 192-7CL \$52.54 ea.

**\*Specify color from page 69\***



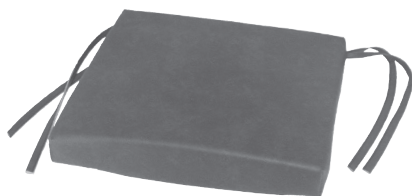

## Contoured Cushion

The Contoured Cushion is used to take the hammock out of the seat, choose between 2" or 3" thickness. Made with closed cell foam and standard fire retardant foam. Choose your covering. This cushion is universal to fit most standard adult 18" and narrow adult 16" wheelchairs. The cushion comes with ties for securing to back of chair.

**\*Specify color from page 69\***

### Contoured Cushion

16"x16"x2" 190-7CL \$69.45 ea.  
18"x16"x2" 190-5CL \$69.45 ea.

16"x16"x3" 190-8CL \$72.12 ea.  
18"x16"x3" 190-6CL \$69.45 ea.



## Wedge Cushion

The wedge cushion helps prevent patient from sliding forward, choose between three different slants, 1" to 3" slant, 2" to 4" slant or 3" to 6" slant. Foam is fire retardant. Choose your covering. This cushion is universal to fit most standard adult 18" and narrow adult 16" wheelchairs. The cushion comes with ties for securing to back of chair.

**\*Specify color from page 69\***

### Wedge Cushion

16"x16" with 1" to 3" Slant 191-4CL \$55.88 ea. 18"x16" with 1" to 3" Slant 191-5CL \$55.88 ea.  
16"x16" with 2" to 4" Slant 191-6CL \$59.48 ea. 18"x16" with 2" to 4" Slant 191-7CL \$59.48 ea.  
16"x16" with 3" to 6" Slant 191-8CL \$63.09 ea. 18"x16" with 3" to 6" Slant 191-9CL \$63.09 ea.

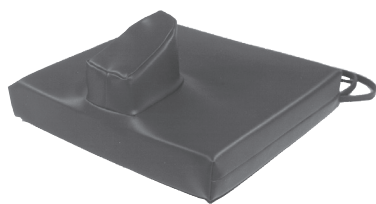

## Abductor Cushion

The abductor cushion helps position patient and prevents patient from sliding forward. Foam is fire retardant. Choose your covering. This cushion is universal to fit most standard adult 18" and narrow adult 16" wheelchairs. The cushion comes with ties for securing to back of chair.

**\*Specify color from page 69\***

### Abductor Cushion

16"x16"x3" 192-6CL \$74.03 ea.  
18"x16"x3" 192-5CL \$74.03 ea.



## Standard Gel Cushion

Maximum comfort, stability and therapeutic effectiveness. Combination of firm and soft foam with gel. Reversible for comfort level. Size: 18"x16"x2".

**\*Specify color from page 69\***

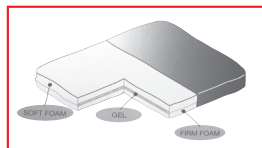

### Gel Cushion

Grey Velour Cover

191-054 \$66.27 ea.

Black Waterproof and Fire-Retardant Cover

191-068 Disc.

### Can't find what you're looking for?

#### Let us make it for you!

Ocelco has its own in house Wood Shop and Custom Upholstery Shop. Let us know what you need and we will make it for you. Special size wheelchair upholstery, custom cushions (see page 56-57), adaptive seating, or whatever you may need. Let Ocelco make it to your specifications. We're here to help, please do not hesitate to call us so we can make your special request for you.

Remember "We're The Friendly People"

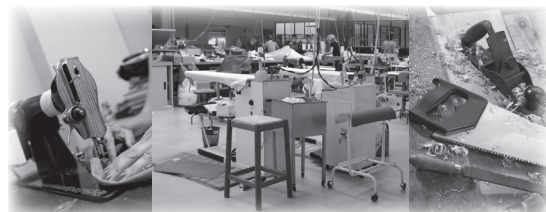

# Build-A-Cushion

Have a special request?  
We'll Customize it for you!

Build a cushion to meet your needs and specifications. If there is an option or size you are looking for and it is not listed below, please call and we will be happy to quote you a price and build your cushion today!

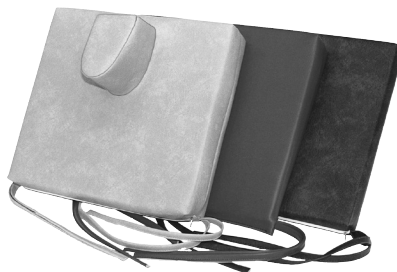

**Note: No returns on custom built cushions, for more details on returns see company policy on front inside cover.**

**\*Choose color and material from page 69\***

## Build Your Part Number Below

CU	Size	Gel Insert	Bottom Style	Top Shape	—	Thickness	Foam Type	Wood Base	Covering Code <small>See page 69</small>

### 1. Size

- 1 = 16"x16" N/C
- 2 = 18"x16" N/C
- 3 = 20"x16" + \$12.00
- 4 = 18"x18" + \$12.00
- 5 = 20"x18" + \$16.00
- 6 = 22"x18" + \$19.00
- 7 = 24"x18" + \$23.00

### 2. Gel Insert

- 1 = No Gel Insert N/C
- 2 = Gel Insert + \$59.00 ea.

### 3. Bottom Style

- 1 = Flat N/C
- 2 = Contoured + \$26.00 ea.
- 3 = Flat, No Slip Fabric + \$15.00 ea.
- 4 = Contoured, No Slip Fabric + \$37.00 ea.

### 4. Top Shape

- 1 = Flat N/C
- 2 = Abductor Pad + \$24.00 ea.

### 5. Thickness

	Base Price
1 = 1" Thick	\$45.16 ea.
2 = 1½" Thick	\$45.16 ea.
3 = 2" Thick	\$45.16 ea.
4 = 3" Thick	\$50.52 ea.
5 = 4" Thick	\$55.26 ea.
6 = 1" to 3" Wedge	\$53.67 ea.
7 = 2" to 4" Wedge	\$57.07 ea.
8 = 3" to 6" Wedge	\$60.47 ea.

### 6. Foam Type

- 1 = Standard Foam (Fire Retardant) N/C
- 2 = ½" T-Foam and Standard Foam + \$33.00 ea.
- 3 = 1" T-Foam and Standard Foam + \$45.00 ea.

### 7. Wood Base

- 1 = No Wood Base N/C
- 2 = ½" 9 ply Marine Grade Plywood Base + \$26.00 ea.

## 100% GEL Flotation Cushion



The ultimate flotation for prevention and treatment of decubitus problems and maximum seat comfort. Low viscosity water based gel enclosed in heat sealed, heavy gauge vinyl plus cover.

**Size:** 18" x 16" x 2"

### Cushion

Blue Dacron/Cotton Cover

191-061

\$76.14 ea.

Waterproof and Fire-Retardant Cover

191-060

Disc.

## ROHO Positioning and Therapeutic Seating System Products



For individuals who require special positioning of the pelvis or thighs and risk of skin breakdown, the Quadtro, with 4" cell height and air in place progressive positioning is the cushion of choice. The Quadtro cushion with the Isoflap valve open, provides the same therapeutic valve as a single compartment high profile cushion.

**Quadtro Cushion** Choose Size (WxD)

707-501-SZ \$458.15 ea.



With 4" cells, the High Profile is the cushion of choice for individuals who suffer from ischemic ulcers (pressure sores) or who have a history of tissue breakdown. It utilizes a multi-cellular, air-filled design allowing adjustment to the unique contours of the individual user.

**High Profile (Single Valve)** Choose Size (WxD)

707-506-SZ \$458.15 ea.



The Low Profile single compartment cushion with 2" cells offers active users protection against skin breakdown. 2" interconnected air cells maximize stability of the user while protecting from a potential risk of tissue break down. Lightweight and portable, this cushion is ideal for the active individual.

**Low Profile (Single Valve)** Choose Size (WxD)

707-507-SZ \$438.10 ea.



The contoured design combined with the simple operation of the ISOFLO® Memory Control Unit provides a new level of postural control and stability that has never been achieved in an air cushion. The contoured design positions the pelvis back in the wheelchair, and centers the user comfortably in the middle of cushion. The ISOFLO® Memory Control Unit locks air into each of the four compartments, providing stability by minimizing side-to-side and front to back motion.

**Contour Select** Choose Size (WxD)

707-509-SZ \$410.15 ea.



The ENHANCER cushion uses AIR IN PLACE positioning in a uniquely designed two-manifold system for enhanced midline channeling of the femurs, lateral stability and tissue protection.

**Enhancer Cushion** Choose Size (WxD)

707-510-SZ \$428.96 ea.

## Star Cushions

Therapeutic air-flow system providing added stability, positioning and state-of-the-art pressure management.

The Short Contour Cushion (2" cell height) is recommended for the active individual that can perform independent weight shifts, or for those individuals who are at low risk for pressure ulcers. The Short Contour is the perfect cushion for sports enthusiasts as well, providing the ideal seating surface for your everyday chair, sports chair or other sports equipment.

**Short Contour** Choose Size (WxD)

707-282-SZ \$295.52 ea.

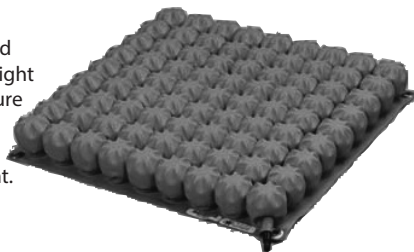

The Mid Contour Cushion (3" cell height) is recommended for individuals who require a cell height that provides a high level of tissue protection and treatment while offering greater ease in transfers in and out of the cushion. The Mid Contour cell height has proven to be ideal for the pediatric client, providing deep immersion for high levels of tissue protection and treatment along with a lower cell height for the pediatric frame.

**Mid Contour** Choose Size (WxD)

707-283-SZ \$295.52 ea.

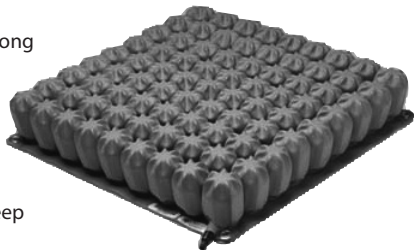

The Standard Contour Cushion (4" cell height) is Star Cushion Products premier cushion for the prevention and treatment of pressure ulcers. Flexible, interconnected 4" air cells allow for deep immersion into the cushion providing constant low pressures across the contact seating surface. In addition, the cells move and shape to the contact area providing a low shear, low friction surface ideal for the prevention and healing of up to and including a Stage IV pressure ulcer.

**Standard Contour** Choose Size (WxD)

707-284-SZ \$288.06 ea.

The CXR Cushion is designed to minimize coccyx pressures through a combination of 2" Cells under the coccyx area, and 4" cells throughout the remaining cushion surface. The dual valve configuration allows you to adjust both the 4" and 2" cells separately achieving individualized immersion, and ultimately constant low sitting pressures. The 2" cells allow for immersion while also providing added relief and protection under the coccyx area. 16 standard configurations address specific individualized seating needs. Ideal for the individual who has, or is at risk for the development of pressure ulcers.

**CRX with Coccyx Area** Choose Size (WxD)

707-281-SZ \$343.28 ea.

**Isolated 2" High Air Cells  
Minimize Coccyx Pressure**

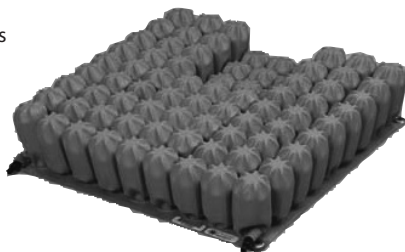

## Starlock Cushion

The Starlock cushion is designed to provide continuous support by submersing the user into a cushion of multiple air-filled cells, maneuvering to a desired position then "locking" the vital posture. Cushion personalization is taken to a new level through Starlock's patented technology called "lockpockets". This unique patent pending cushion enables varying degrees of air-flow communication between cells, and can be utilized with or without enabling the "lockpockets".

**2" Cell Height, Single Valve** Choose Size (WxD)

707-285-SZ \$319.40 ea.

**3" Cell Height, Single Valve** Choose Size (WxD)

707-286-SZ \$319.40 ea.

**4" Cell Height, Single Valve** Choose Size (WxD)

707-287-SZ \$326.87 ea.

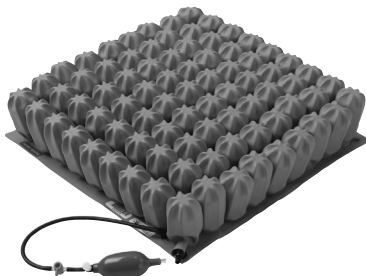



## Ring Cushion



**16" Inflatable Vinyl Ring**  
20 gauge heavy-duty vinyl.  
Unique Roberts valve for easy inflation.  
**Vinyl Ring** 206-900 \$12.18 ea.



**Inflatable Rubber Ring**  
Top quality rubber.  
Special valve designed for easy inflation.  
**Rubber Ring** 206-901 \$25.71 ea.

## Wheelchair Pad

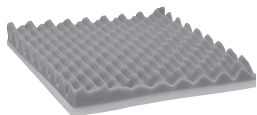

Provides soft support and pressure relief.  
Prevents sliding which promotes correct positioning.

**Wheelchair Pad**  
2" (standard) 206-519 \$13.73 ea.  
3" 206-520 \$17.55 ea.

## Wheelchair Cushion with Back Support

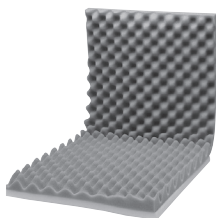

Promotes good posture while providing proper support.

**Wheelchair Cushion**  
206-521 \$25.57 ea.

## Stainless Steel Fixed Clamp

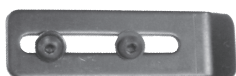

Black, zinc plated stainless steel  
Fits 7/8" or 1" Tubing  
702-002 \$6.47 ea.

## Seat and Back Cushion



### Cushions

Standard 191-041 Disc.  
Reclining 191-044 Disc.

## Aluminum Hip, Thigh and Trunk Support Bracket



Black, Anodized Aluminum  
**Brackets**

Straight 703-001 \$20.94 ea.  
1" Offset 703-002 \$22.33 ea.  
2" Offset 703-003 \$22.33 ea.

## Aluminum Flip Down Abductor Bracket



Black, Anodized Aluminum  
Bracket 706-001 \$100.35 ea.

## Stainless Steel Standard Clamp



Black, zinc plated stainless steel  
**Standard Clamp** \$10.86 ea.  
Fits 7/8" Tubing 702-001  
Fits 1" Tubing 702-003

## S/S Quick Release Clamp



Black, zinc plated stainless steel  
**Standard Clamp** \$17.82 ea.  
Fits 7/8" Tubing 702-007  
Fits 1" Tubing 702-008

## Clamp-On Trunk Support Bracket



Black, Anodized Aluminum  
Fits 7/8" or 1" Tubing  
702-010 \$75.47 ea.

## S/S Adjustable Drop Hook



**Drop Hook** \$14.20 ea.  
Fits 7/8" Tubing 701-007  
Fits 1" Tubing 701-008

Black, zinc plated stainless steel  
**Includes attaching hardware**

## Stainless Steel Standard Drop Hook



Black, zinc plated stainless steel  
**Includes attaching hardware**

**Fits 7/8" Tubing** \$6.47 ea.  
1" Drop 701-001  
1-1/2" Drop 701-004  
2" Drop 701-002  
2-1/2" Drop 701-005  
3" Drop 701-003

**Fits 1" Tubing**  
1" Drop (\$13.78) 701-009  
1-1/2" Drop (\$6.47) 701-012  
2" Drop (\$6.47) 701-010  
2-1/2" Drop (\$6.47) 701-013  
3" Drop (\$6.47) 701-011

## Fixed Trunk Support

Made with Naugahyde, nylon, or mesh, ½" foam and ½" wood. Attaches to either drop hook or solid backs. Black, anodized aluminum bracket makes it adjustable. Special sizes and materials available upon request.

**Sold in pairs.**

**\*Choose color and material from page 69\***

Straight	\$80.20 a pair	1" Offset	\$104.27 a pair	2" Offset	\$104.27 a pair
Small (4"x5")	703-400-CL	Small (4"x5")	703-401-CL	Small (4"x5")	703-402-CL
Medium (5"x6")	703-403-CL	Medium (5"x6")	703-404-CL	Medium (5"x6")	703-405-CL
Large (6"x7")	703-406-CL	Large (6"x7")	703-407-CL	Large (6"x7")	703-408-CL



## Clamp-On Trunk Support

Made with Naugahyde, nylon, or mesh, ½" foam and ½" wood. Attaches to 1" or 7/8" tubing. Black, anodized bracket makes it adjustable. Special material and sizes are available upon request.

**Sold in pairs.**

**\*Choose color and material from page 69\***

Trunk Support	\$140.36 a pair
Small (4"x5")	703-421-CL
Medium (5"x6")	703-423-CL
Large (6"x7")	703-425-CL



## Flip Down Abductor Pad and Bracket

Made with Naugahyde, nylon, or mesh, ½" closed cell foam and wood. Attaches to either drop hook or solid seats. Black, anodized aluminum bracket with stainless steel components make it adjustable.

**\*Choose color and material from page 69\***

Abductor Pad and Bracket	\$121.99 ea.
Small (5"x3"x4")	706-200-CL
Medium (6"x4"x5")	706-201-CL
Large (7"x4-1/2"x5")	706-202-CL



## Adjustable Drop Hook Back

Made with Naugahyde, nylon or mesh, 1" foam, and ½" wood. Fits 18" adult wheelchair. Special sizes and materials available upon request. Black, zinc plated stainless steel hardware.

**When ordering specify:** Proposed Make of Chair, Proposed Model of Chair, Width of Chair and Arm style (Removable or Fixed Arms).

**\*Choose color and material from page 69\***

Standard Clamp with Adjustable Hooks	Quick Release with Adjustable Hooks
Fits 7/8" Tubing 701-300-CL \$189.55 ea.	Fits 7/8" Tubing 701-303-CL \$194.90 ea.
Fits 1" Tubing 701-301-CL \$189.55 ea.	Fits 1" Tubing 701-304-CL \$194.90 ea.



## Solid Back Insert

Made with Naugahyde, nylon or mesh, 1" foam, and ½" wood. 14½"x15½", fits 18" adult wheelchair. Special sizes and materials available upon request.

**When ordering specify:** Proposed Make of Chair, Proposed Model of Chair, Width of Chair and Arm style (Removable or Fixed Arms).

**\*Choose color and material from page 69\***

Solid Back Insert 701-4CL \$77.20 ea.



## Adjustable Drop Hook Seat

Made with Naugahyde, nylon, or mesh. 1½" foam and ½" wood. Fits 18" adult wheelchair. Special sizes and materials available upon request. Black, zinc plated stainless steel hardware.

**When ordering specify:** Proposed Make of Chair, Proposed Model of Chair, Width of Chair and Armstyle (Removable or Fixed Arms).



**\*Choose color and material from page 69\***

### Standard Clamp with Adjustable Hooks

Fits 7/8" Tubing  
702-300-CL \$176.45 ea.  
Fits 1" Tubing  
702-301-CL \$176.45 ea.

### Quick Release with Adjustable Hooks

Fits 7/8" Tubing  
702-303-CL \$182.46 ea.  
Fits 1" Tubing  
702-304-CL \$182.46 ea.

## Solid Back Insert

Made with Naugahyde, nylon or mesh, 1" foam, and ½" wood. 14½"x15½", fits 18" adult wheelchair. Special sizes and materials available upon request.

**When ordering specify:** Proposed Make of Chair, Proposed Model of Chair, Width of Chair and Arm style (Removable or Fixed Arms).

**\*Choose color and material from page 69\***

Solid Back Insert 701-4CL \$77.20 ea.



## Adjustable Drop Hook Back

Made with Naugahyde, nylon or mesh, 1" foam, and ½" wood. Fits 18" adult wheelchair. Special sizes and materials available upon request. Black, zinc plated stainless steel hardware.

**When ordering specify:** Proposed Make of Chair, Proposed Model of Chair, Width of Chair and Arm style (Removable or Fixed Arms).

**\*Choose color and material from page 69\***

### Standard Clamp with Adjustable Hooks

Fits 7/8" Tubing 701-300-CL \$189.55 ea.  
Fits 1" Tubing 701-301-CL \$189.55 ea.

### Quick Release with Adjustable Hooks

Fits 7/8" Tubing 701-303-CL \$194.90 ea.  
Fits 1" Tubing 701-304-CL \$194.90 ea.



## Hip and Thigh Support Pads

Made with Naugahyde, 1" foam and ½" wood with straps to attach to chair. **Sold in pairs.**

**\*Choose color and material from page 69\***

Support Pads \$65.17 a pair  
15"x4-1/2" 703-204-CL



## Fixed Hip and Thigh Supports

Made with Naugahyde, nylon, or mesh, ½" foam and ½" wood. Attaches to either a drop hook or solid seat. Black, anodized aluminum bracket makes it adjustable. Size: 16"x5" with specialty sizes available. **Sold in pairs.**

**\*Choose color and material from page 69\***

### Hip and Thigh Support

Straight 703-200-CL \$74.86 a pair  
1" Offset 703-201-CL \$80.20 a pair  
2" Offset 703-202-CL \$80.20 a pair

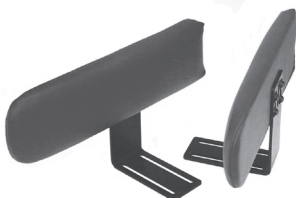

## Adjustable Head and Neck Support

Made with naugahyde, nylon, or mesh, ½" closed cell foam. Attaches to drop hooks or solid backs. Black, anodized aluminum bracket makes it adjustable. Special sizes and materials available upon request.

**\*Choose color and material from page 69\***

Head and Neck Support 705-200-CL \$86.89 ea.



## PVC Shower/Commode Chairs

### Features:

- Deluxe elongated extra heavy-duty contoured open front seat.
- All casters and backs are double wall reinforced with schedule 40, 1" PVC.
- Aesthetically pleasing, with curved arms (no sharp edges).
- Anti-slip safety hand grips (Arm Section).
- Fast drying and removable mesh back.
- Personal pouch/pocket.
- All models fit over standard height toilet seats.
- Structurally designed with 30% more security (with four stainless steel bolts on commode seat).
- All casters have threaded stem for extra security and safety, casters will not fall or pull out with normal use.
- Chairs shipped Royal Blue unless otherwise specified.

### CUSTOM SIZE

Custom Sizes and configurations are available upon request. Most Chairs can be built to your specifications.



Vertical Open Front

Specify color from page 69

**CASTER UPGRADES MUST BE PLACED WITH ORDER**

Size	Description	Caster Size	Part#	Price
15"	Small PVC Commode/Shower Chair	Standard w/ 3" Heavy Duty	223-737-CL	\$144.26 ea.
	Twin Wheel Caster Upgrade	3" Twin Wheel	243-210	No Charge
	Twin Wheel Caster Upgrade	4" Twin Wheel	243-211	\$39.22 set
	Heavy Duty Wagner Caster Upgrade	4" Heavy Duty Wagner	243-216	\$35.29 set

### Specifications:

- Between Arms: 15"
- Seat Clearance: 16.5"
- Dimensions: 19"x21.25"x38"

**Weight Capacity:** 300 lbs.

Size	Description	Caster Size	Part#	Price
18"	Standard PVC Commode/Shower Chair	Standard w/ 3" Heavy Duty	223-700-CL	\$155.22 ea.
18"	Folding PVC Commode/Shower Chair	Standard w/ 3" Heavy Duty	223-707-CL	\$176.12 ea.
18"	Tilted Seat PVC Commode/Shower Chair	Standard w/ 3" Heavy Duty	223-713-CL	\$140.98 ea.
18"	Vertical Open PVC Commode/Shower Chair	Standard w/ 3" Heavy Duty	223-706-CL	\$182.09 ea.
	Twin Wheel Caster Upgrade	3" Twin Wheel	243-210	No Charge
	Twin Wheel Caster Upgrade	4" Twin Wheel	243-211	\$39.22 set
	Heavy Duty Wagner Caster Upgrade	4" Heavy Duty Wagner	243-216	\$35.29 set
	Heavy Duty Wagner Caster Upgrade	5" Heavy Duty Wagner	243-217	\$58.82 set

### Specifications:

- Between Arms: 18"
- Seat Clearance: 17.5"
- Dimensions: 22"x22.75"x38.5"

**Weight Capacity:** 300 lbs.

Size	Description	Caster Size	Part#	Price
21"	PVC Commod/Shower Chairs	Standard w/ 3" Heavy Duty	223-721-CL	\$182.09 ea.
	Heavy Duty Wagner Caster Upgrade	4" Heavy Duty Wagner	243-216	\$35.29 set
	Heavy Duty Wagner Caster Upgrade	5" Heavy Duty Wagner	243-217	\$58.82 set

### Specifications:

- Between Arms: 21"
- Seat Clearance: 18.75"
- Dimensions: 25"x25.5"x38.5"

**Weight Capacity:** 350 lbs.



**SKU: 208-090**  
TR 1000 Shower  
Transport Chair

**Price: \$6,325.00**



**SKU: 208-150**  
Comfortline Bath System

**Price: \$10,259.21**



**SKU: 208-096-SZ-CL**  
TR 2000 Shower Trolley

**Price: \$5,640.79**



**Harvy Hard  
Wood Cane**  
1" x 36"

**Price: \$15.41**

**SKU: 241-123-CL**



**Voyager  
Euro-Style  
Rollator**

**Price: \$217.57**

**SKU: 240-306-CL**



**3-In-1 Toilet Assist  
Commode with Back**

**Price: \$113.93**

**SKU: 221-108**



**Drive Medical  
Power Neb  
Ultra Nebulizer**

**Price: \$37.90**

**SKU: 207-279**



**Drive Compact  
Compressor  
Nebulizer**

**Price: \$52.80**

**SKU: 207-281**



**Dynarex  
Compressor  
Nebulizer**

**Price: \$31.37**

**SKU: 207-210**

## Rock King X300

Rock-King X3000 Wheelchairs are ideal for patients who need safety and supportive comfort while reducing or eliminating the need for protective restraints.

### Features:

Chair Color: Ambiance/Brown  
 Seat Height from Floor (Adjustable in 1-inch increments): 19"  
 Overall Width: 28.5"  
 Chair Weight (no accessories) 63 lb.  
 Overall Length (without footrests) 32"  
 Seat Width: 20"  
 Seat Depth: 16"  
 Height of Backrest from Seat: 32"  
**Weight Capacity:** 350 lbs

**NEW  
PRODUCT**



### Rock King X3000 Wheelchair

20" Wide Rock King X3000

285-500 \$1,968.75 ea.

Optional Elevating Legrests

285-554 \$473.24 ea.

## Steel Transport Chair

### Specifications:

Overall Width 17" Chair: 18" Back Height: 18"  
 Overall Width 19" Chair: 20" Seat Width: 17" and 19"  
 Width Folded: 8" Seat Depth: 16"  
 Overall Height: 39" Length w/Rigging: 33"  
 Floor to Seat Height: 19" **Weight Capacity:** 250 lbs.  
 Silver Vein frame finish

### Fixed Full Arms

17" Wide 010-334 \$152.57 ea.

19" Wide 010-336 \$152.10 ea.



**drive**  
MEDICAL DESIGN & MANUFACTURING



## Silver Sport 2

### Features:

Powder coated silver vein steel frame.  
 Padded armrest.  
 Embossed vinyl upholstery is durable, lightweight, attractive and easy to clean.  
 Urethane tires mount on composite wheel provides durability and low maintenance.  
 Push to lock brakes.  
 Carry pocket on backrest provides additional convenience.

**Weight capacity:** 250 lbs.

**AS LOW  
AS  
\$161.14**

**drive**  
MEDICAL DESIGN & MANUFACTURING



### 16" Wide Wheelchairs

Fixed Arms with Footrests

010-122-F

Disc.

Fixed Arms with Legrests

010-122-L

Disc.

Detachable Desk Arms with Footrests

010-123-F

\$206.90 ea.

Detachable Desk Arms with Legrests

010-123-L

\$238.61 ea.

### 18" Wide Wheelchairs

Fixed Arms with Footrests

010-125-F

\$211.33 ea.

Fixed Arms with Legrests

010-125-L

\$229.03 ea.

Detachable Desk Arms with Footrests

010-124-F

\$206.90 ea.

Detachable Desk Arms with Legrests

010-124-L

\$218.31 ea.

### 20" Wide Wheelchairs

Detachable Desk Arms with Footrests

010-128-F

\$211.67 ea.

Detachable Desk Arms with Legrests

010-128-L

\$221.04 ea.

## Foldable Seated Knee Scooter

Foldable Seated Knee Scooters are proven, durable mobility aid that provides maximum mobility for a full range of foot, ankle, knee, and leg injuries. This scooter keeps the injured leg cradled and elevated which hastens recovery by keeping the injured area from bearing any weight without sacrificing any mobility. A perfect alternative to those who cannot use a traditional knee scooter.

### Features:

- A firm, yet soft foam calf pad that can be attached to either side accommodate and elevate the injured leg.
- Adjustable handlebar and seat height allow you to cruise in optimal comfort.
- Dual handle-mounted lockable brakes are able to bring the R270 to a complete stop.
- Premium thickly padded seat reduces strain and fatigue from extended use.
- Easily folds for quick storage and transportation.
- A free attachable wire basket is included to have hands free access to your daily necessities.
- 300 lb. Weight Limit

### Color Choice

- Blue 240-189-69 \$231.34 ea.
- Red 240-189-20 \$231.34 ea.



## Knee Walker

Knee Walkers make relying on upper body strength to achieve uncomfortable results with crutches a problem of the past. This knee scooter is ideal for individuals recovering from foot surgery, breaks, sprains, amputations, ulcers, or other lower leg and foot related injuries.

### Features:

- Contoured, soft padded knee platform keeps the injured leg from bearing any weight.
- Adjustable knee platform and handlebar height.
- Dual handle-mounted lockable brakes to control your speed and switch into parking mode.
- Easy to fold and store for simpler transportation.
- Tucked in rear wheels to eliminate the chance of colliding with during use.
- 300 lb. Weight Limit

240-187 \$164.44 ea.



## Bariatric Knee Walker

### Features:

- Weight Capacity of up to 500 lbs.
- Fixed steering to ensure the user does not tip over from awkward turns.
- Adjustable rear wheels to accommodate either leg and prevent collision during use.
- A lockable brake crowns the top of the handlebar offering control and a parking mode.
- Folds down flat easily allowing for effortless transportation and storage

240-190 \$246.27 ea.



### Drive Medical Trigger Release Walker w/ 5" Wheels



Weight Capacity up to 350 lbs

240-178-AD \$71.67 ea.

### MRI Safe Bariatric Walker



Weight Capacity up to 500 lbs

240-108 \$340.52 ea.

### Invacare Heavy Duty Dual Release Paddle Walker



Weight Capacity up to 500 lbs

240-183 \$154.10 ea.

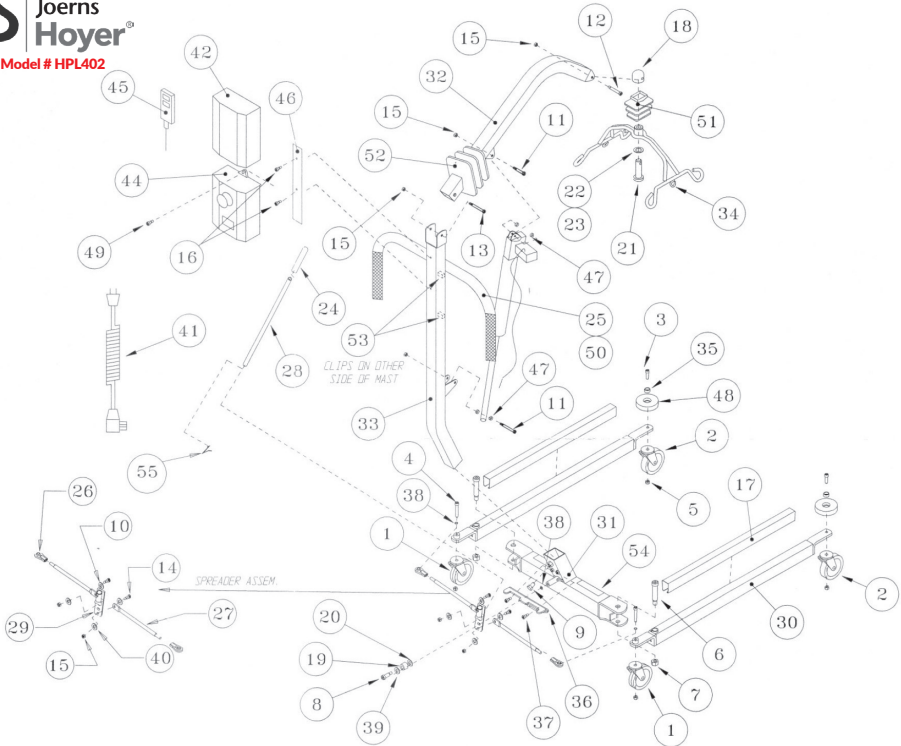

Fig. Part #	Description	Price	
1	300-137	3" Dual Wheel Caster w/Brake	Disc.
2	300-138	3" Dual Wheel Caster w/o Brake	\$80.10 ea.
3	300-139	Screw (3/8-16 x 1 1/2")	\$5.42 ea.
4	300-140	Screw (3/8-16 x 2 1/2")	\$13.51 ea.
5	300-331	Lock Nut (3/8")	\$6.12 ea.
6	300-127	Bolt (5/8-11 x 2 3/4")	\$33.51 ea.
7	300-141	Nut (5/8-11)	\$3.86 ea.
8	300-134	Bolt (3/8-16 x 1")	\$12.37 ea.
9	300-142	Bolt (1/2-13 x 3/4")	\$15.49 ea.
11	300-143	Bolt (5/16-18 x 1 3/4")	\$7.39 ea.
12	300-144	Bolt (5/16-18 x 2")	\$7.54 ea.
13	300-145	Bolt (5/16-18 x 2 1/2")	\$10.71 ea.
14	300-146	Bolt (5/16-18 x 3/8")	\$18.15 ea.
15	300-147	Nut (5/16-18)	\$0.79 ea.
16	300-148	Screw (10-32 x 3/8")	\$3.17 ea.
17	300-149	Plastic Scuff Guard	\$47.09 ea.
18	300-151	Pivot Spacer for Cradle	\$34.07 ea.
19	300-124	Spring Spacer (1/2" x 1" x 3/4")	\$47.53 ea.
20	300-153	Washer (1" x 17/32" x 1/16")	\$5.59 ea.
22	300-155	Thrust Washer	\$19.90 ea.
24	300-105	Black Plastic Grip	\$23.54 ea.
25	300-159	Foam Grip	\$30.84 ea.
26	300-205	Tie Rod End	\$24.73 ea.
28	300-161	Spreader Handle	\$47.47 ea.
29	300-206	Adjusting Lever	Disc.
30	300-164	Base Leg	\$116.81 ea.
31	300-165	Center of Base	\$260.78 ea.
32	300-167	Boom Only	\$168.38 ea.

**Visit our Website for  
Additional Accessories**

Fig. Part #	Description	Price	
33	300-168	Mast Only	\$168.47 ea.
34	300-169	Cradle Only	\$226.04 ea.
35	300-207	Leg Bumper Spacer	\$5.08 ea.
36	300-170	Spreader Lock	\$32.51 ea.
37	300-171	Screw (1/4-20 x 3/4")	\$8.07 ea.
38	300-172	Washer (5/8 x 3/8" x 1/16")	\$2.42 ea.
39	300-173	Washer (91.00 x .530 x .062)	\$3.28 ea.
40	300-174	Washer (3/4 x 5/16" x 1/16")	\$0.61 ea.
41	300-175	Power Cable	\$85.71 ea.
42	300-184	Battery Box	\$296.36 ea.
43	300-185	Actuator	\$1,157.22 ea.
44	300-186	Control Box	\$606.90 ea.
45	300-187	Hand Set	\$177.00 ea.
46	300-188	Mounting Bracket for Control Box	\$76.12 ea.
47	300-189	Washer (5/8" x 3/8" x 1/8")	\$3.94 ea.
48	300-190	Front Leg Bumper	\$68.84 ea.
49	300-191	Mounting Screw for Battery & Control Box	\$0.92 ea.
50	300-208	Plug (7/8")	\$3.86 ea.
51	300-192	Cradle Boot	\$55.56 ea.
52	300-193	Mast/Boom Boot	\$69.39 ea.



**\$769.44**

**400  
LBS**  
Bariatric

## Hoyer® Versatile

### Features:

- Non-sway cradle increases patient stability.
- Same durable rectangular tubing construction found on more expensive lifters.
- Full travel height range allows lifting from floor.
- Easy to adjust base legs lock securely into open and closed positions.
- Disassembles for easy storage.
- Manufactured by the most recognizable name in patient lifting.
- Accommodates Hoyer 4-point slings and traditional slings.
- Weight Capacity:** 400 lbs.
- Convenient rotating pump handle allows operation from both sides of lifter.
- Priced for reimbursement.

### Hydraulic Patient Lifter

Painted	302-120	\$769.44
Chrome	302-122	\$840.28



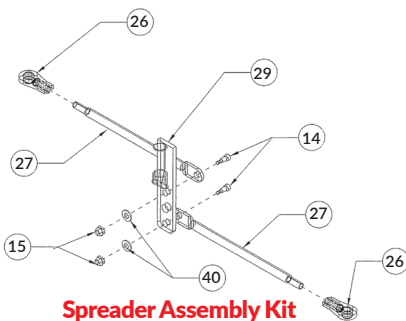
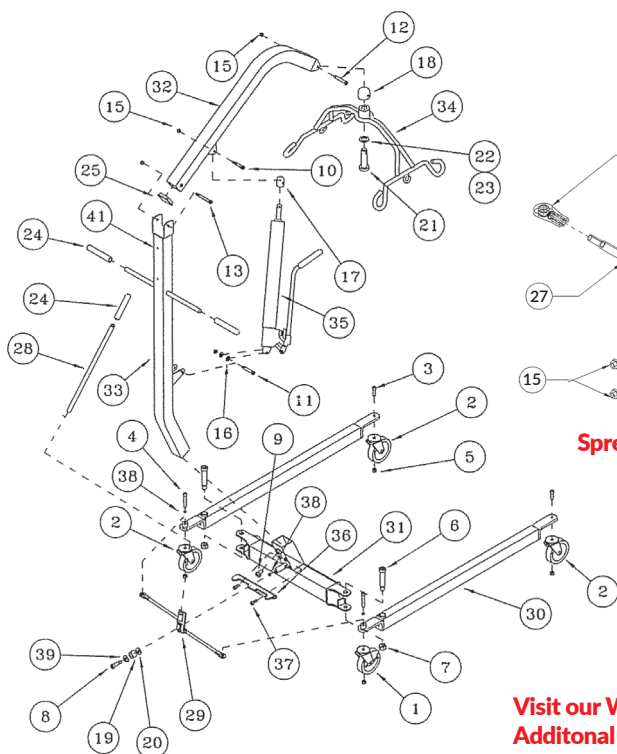

Spreader Assembly Kit

Visit our Website for  
Additional Accessories

Fig.	Part #	Description	Price
1, 4, 5, 38	300-258	Kit, caster, rear, w/brake	\$228.38 ea.
1-9, 14, 15, 19, 20, 24, 26-31, 36-40	300-259	Kit, base complete	\$849.91 ea.
10, 12, 13, 15, 25, 32	300-260	Kit, boom and hardware	Disc.
10-13, 15-17 12, 15, 18, 21, 22	300-261 300-262	Kit, hardware, jack/boom Kit, hardware, cradle	Disc. \$69.06 ea.
12, 15, 18, 21, 22, 34	300-263	Kit, cradle, complete	\$219.25 ea.
2, 3, 5	300-264	Kit, caster, front w/o brake	\$88.53 ea.
2, 4, 5, 38	300-265	Kit, caster, rear w/o brake	\$94.22 ea.
24	300-266	Kit, grips (set of 4)	\$14.59 ea.
24, 28	300-267	Kit, spreader handle	\$44.33 ea.
35	300-176	Kit, Jack assembly	\$431.03 ea.
4, 11, 13, 15, 16, 33, 41	300-268	Kit, mast and hardware	\$236.16 ea.
4, 8, 14, 15, 19, 20, 24, 26-29, 36-40	300-269	Kit, spreader assembly	\$328.69 ea.

## Classic Hoyer®

The Hoyer Lifter is designed to safely and comfortably transfer a person from bed to chair, commode or car protecting both the person being transferred and the attendant from strain or injury. Designed for easy operation, Hoyer lifters are available with interchangeable adjustable "U" or nonadjustable "C" bases with a chrome finish.

**Maximum Weight Capacity:** 400 lbs.

### Hydraulic Patient Lifter

"U" Base	302-110	\$809.72
"C" Base	302-111	\$950.25

Visit our Website for  
Additional Accessories



\$809.72





Model # HPL600

Fig.	Part #	Description
1	300-195	Actuator
2	300-196	Clevis Pin (10 x 38.5)
3	300-184	Battery Box
4	300-197	Control Box
5	300-175	Power Cable
6	300-198	Hand Set
7	300-199	Actuator in Base
8	300-200	Clevis Pin (Base Actuator)
9	300-201	Front Caster
10	300-202	Rear Locking Caster

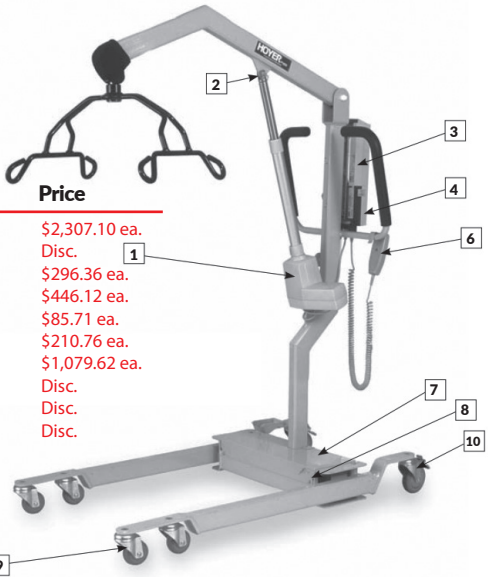

Price
\$2,307.10 ea.
Disc.
\$296.36 ea.
\$446.12 ea.
\$85.71 ea.
\$210.76 ea.
\$1,079.62 ea.
Disc.
Disc.
Disc.

Visit our Website for Additional Accessories



Model # C-HLA

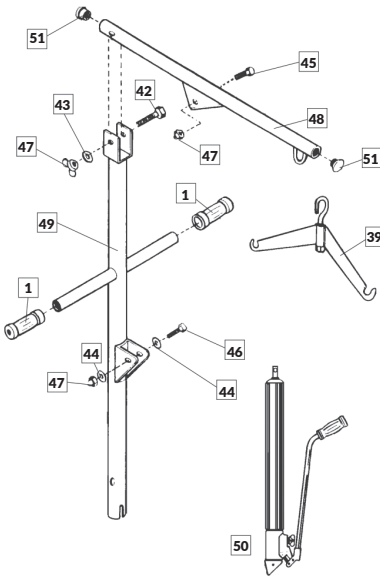

Visit our Website for Additional Accessories

Fig.	Part #	Description	Price
1	300-105	Hand Grip, Black Plastic	\$23.54 ea.
7	300-116	Caster Nut, Chrome	\$23.05 ea.
10	300-114	Leg Pivot Bushing	\$25.36 ea.
12	300-124	Spring Spacer	\$47.53 ea.
15-19	300-283	Latch Plate Hardware Kit	\$52.51 ea.
2, 4, 7	300-109	4" Caster, Front w/o Brake	\$53.00 ea.
20-23, 8	300-284	Tie Rod Hardware Kit	\$107.43 ea.
24	300-119	Mast End Lock	\$21.59 ea.
25	300-120	Base Leg End Cap	\$18.95 ea.
28, 29	300-129	Chrome Base Legs	\$517.24 pr.
		Left & Right	
3, 4, 7, 6	300-110	4" Chrome Caster w/Brake	\$78.29 ea.
31	300-130	Chrome Handle w/Grip	\$55.44 ea.
32, 26, 24, 30, 33, 10, 5	300-288	Center Channel Hardware Kit	\$156.60 ea.
39	300-150	24" Powder Coated V Bar	\$177.36 ea.
42-47	300-157	Boom Hardware Kit	\$28.27 ea.
48	300-162	Chrome Boom	\$281.82 ea.
49	300-158	48" Chrome Mast Standard	\$362.07 ea.
50	300-176	Chrome Hydraulic Jack w/Twist Knob Release	\$431.03 ea.
51	300-166	End Cap	Disc.
8, 9, 11-14	300-282	Adjusting Lever Hardware Kit	Disc.



Model # C-HLA-2

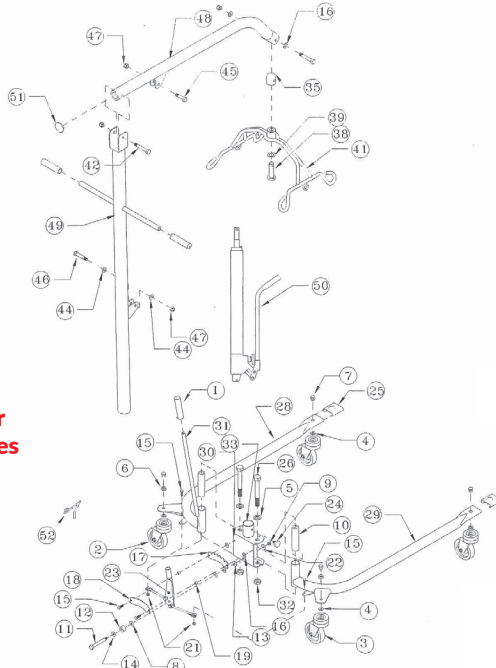

Visit our Website for Additional Accessories

Fig.	Part #	Description	Price
1	300-105	Hand Grip, Black Plastic	\$23.54 ea.
1, 31	300-130	Chrome Handle w/Grip	\$55.44 ea.
1, 49	300-158	48" Chrome Mast Standard	\$362.07 ea.
1-33	300-131	"U" Base Assembly	\$861.14 ea.
12	300-124	Spring Spacer	\$47.53 ea.
2, 4, 7	300-109	4" Caster, Front w/o Brake	\$53.00 ea.
24	300-119	Mast End Lock	\$21.59 ea.
25	300-120	Base Leg End Cap	\$18.95 ea.
28, 29	300-129	Chrome Base Legs Left & Right	\$517.24 ea.
3, 4, 7, 6	300-110	4" Chrome Caster w/Brake	\$78.29 ea.
35-41	300-135	Cradle Assembly	\$265.45 ea.
35-41, 48	300-181	Retro Fit Boom & Cradle	\$555.17 ea.
42-47	300-157	Boom Hardware Kit	\$28.27 ea.
45, 47, 48	300-136	Boom Tube Assembly	\$281.82 ea.
32, 26, 24, 30, 33, 10, 5	300-288	Center Channel Hardware Kit	\$156.60 ea.
50	300-176	Chrome Hydraulic Jack w/Twist Knob Release	\$431.03 ea.



Model # C-CB-L2

Visit our Website for Additional Accessories

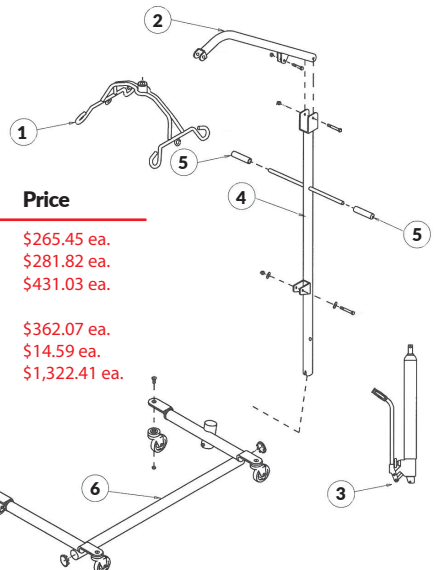

Fig.	Part #	Description	Price
1	300-135	Cradle Assembly	\$265.45 ea.
2	300-136	Boom Tube Assembly	\$281.82 ea.
3	300-176	Chrome Hydraulic Jack w/Twist Knob Release	\$431.03 ea.
4	300-158	48" Chrome Mast, Standard	\$362.07 ea.
5	300-266	Grips (Set of 4)	\$14.59 ea.
6	300-204	"C" Base Assembly	\$1,322.41 ea.

## Drive Medical's Premium Bath Bench

Drive Medical's Premium Bath Bench with Arms and Back is a sturdy, lightweight bathing aid that provides a safe and secure surface for patients to sit during a shower, bath or medical procedure.

### Specifications:

- Width (outside legs): 17"
- Seat Width: 21"
- Depth (outside legs): 14"
- Seat Depth: 2.25"
- Seat Height: 16" to 20.5"
- Weight Capacity: 350 lbs

226-200 \$91.84 ea.

### Features:

- Easy tool free height adjustment.
- Enhanced comfort seat fits all shapes and sizes.
- Tool free removable back, legs and arms.
- Lightweight design has large stable legs with soft non-slip feet.
- 350 lb. Weight Capacity.



## Robotec Bonn Shower Chair

Robotec Bonn shower chairs have a soft and durable polyurethane seat cover for comfortable seating and easy cleaning. The shower chair has 5" hospital grade swiveling and locking castors for secure transfer.

### Specifications:

- Height: 40"
- Width: 22"
- Depth: 34"
- Seat Height: 20.8"
- Seat Width: 18"
- Seat Depth: 18"
- Max Weight: 290 lbs
- Castor: 5"

208-078 \$407.46 ea.

### Features:

- Safety belt for waist
- Belt comfort pad
- Arm rest
- Iv pole



**\*\*Visit Our Website [www.ocelco.com](http://www.ocelco.com) For A Large Line of Medical Equipment\*\***

## Compact Blood Pressure Reader

Compact Blood Pressure Readers portable compact design provides cordless on the go use, the automatic BP monitor comes with sturdy carrying case for safe travel and storage.

### Specifications:

- Battery powered mode: requires three AAA batteries (included)
- Micro-USB power cable (not included)
- Length: 4"
- Width: 4"
- Height: 1.6"
- Arm cuff fit most arms ranging from 8.66" - 16.5"

### Measurements:

- Systolic blood pressure
- Diastolic blood pressure
- Pulse rate (in beats per minute)

### Display:

- Digital blue LCD display
- Low battery indicator

264-538 \$48.02 ea.

### Features:

- Compact portable design
- Quick, accurate readings
- Bright, easy to read LCD display
- Two user capability with 180 measurement memory
- Flexible fit arm cuff most adult arm sizes



## Drive Medical 12" Suction Cup Grab Bar



### Features:

- Indicator "safe secure" suction or "re-affix" suction
- Large suction cups provide an extremely strong hold
- Will not damage property

220-328 \$29.13 ea.

## Standard Utility Tips



These tips can be used on many different items such as Walkers, Canes, Crutches, Quads, Commodes, and many other items.

### Features:

- Fits 7/8" Tube
- Set of 4

- Black 250-217 \$4.18 set

## ChoiceMMed C29C Pulse Oximeter



### Features:

- Measures Oxygen Levels
- Measures Pulse Rate
- Carrying Case Included



## Safety Belts

Made with long wearing web materials. Choose between a simple two piece belt with velcro buckle, plastic buckle or auto buckle. Equipped with your choice of ends to attach to wheelchair, axle mount or beneath upholstery screws. The belts come in three standard sizes, special sizes are available upon request. Specify color of webbing when ordering your belts.

**Note:** Length of belt includes 18" for back of wheelchair.  
**Example:** Actual length of 60" belt is only 42".

### Velcro Buckle

A. Upholstery Screw Mount	\$14.96 ea.	B. Axle Mount	\$15.75 ea.
60" Belt	190-111-CL	60" Belt	190-129-CL
72" Belt	190-103-CL	72" Belt	190-130-CL
90" Belt	(\$15.65) 190-113-CL	90" Belt	190-131-CL

### Plastic Buckle

C. Upholstery Screw Mount	\$15.44 ea.	D. Axle Mount	\$16.28 ea.
60" Belt	190-112-CL	60" Belt	190-126-CL
72" Belt	190-124-CL	72" Belt	190-127-CL
90" Belt	190-125-CL	90" Belt	190-128-CL

### Auto Buckle

E. Upholstery Screw Mount		F. Axle Mount	\$23.23 ea.
60" Belt	(\$22.38) 190-104-CL	60" Belt	190-116-CL
72" Belt	(\$23.23) 190-122-CL	72" Belt	190-120-CL
90" Belt	(\$23.23) 190-123-CL	90" Belt	190-121-CL

**New style safety buckle**

**See Page 69 for Web Colors**

## Safety Belt & Cuff



The patented cuff provides added safety. Eliminates easy access to the velcro closure ensuring fewer accidents. Mounts beneath upholstery screws on back of chair. Special sizes upon request. **See Page 69 for Web Colors**

**Safety Belts and Cuff** \$14.96 ea.

Wheelchair Belt 60"	190-100-CL
Wheelchair Belt 72"	190-101-CL
Geri-Chair 72"	190-102-CL

## Butterfly Safety Belt



Made with 1½" web, 1½" plastic side release buckles and Naugahyde. Attaches to wheelchair beneath upholstery screws or screws to solid backs. Ideal for patients needing extra support while sitting in chair. Specify color of Naugahyde and webbing when ordering. Special sizes available.

**See Page 69 for Naugahyde Colors**

**Butterfly Safety Belt** \$48.80 ea.

Small	190-117-CL
Medium	190-118-CL
Large	190-119-CL

## Stainless Steel Trays



**Stainless Steel Open Corners Tray**

213-105-SM \$83.33 ea.  
 213-105-MD \$90.57 ea.



**Stainless Steel Tray Open Corners**

213-107 \$83.33 ea.



**Stainless Steel Tray**

213-109-SM \$49.18 ea.  
 213-109-MD \$82.51 ea.



## Heavy Duty Pill Crusher

The Ocelco Die-Cast Metal Pill Crusher easily reduces pills to powder, strong enough for institutional use, perfect for hospitals, nursing home, and pharmacies.

### Features:

- Easily reduces pills to powder.
- Strong enough for institutional use.
- Can be mounted to med-carts, table tops, etc. with mounting base.
- Rubber base pads reduce reverberation between crusher and surface.
- Nylon washers reduce reverberation between the handle and the base.

## New Changes mean a 50% Quieter Pill Crusher!



<b>Metal Pill Crusher</b>	104-233	\$76.43 ea.
3/4 oz. Souffle Cups, 1000 ct	104-246	\$19.59 ea.
3/4 oz. Souffle Cups, 5000 ct	104-245	\$84.31 ea.



**Rubber Base Pads** reduce reverberation between Pill Crusher and Table Surface

**Nylon Washers** reduce reverberation between the Handle and Base



Place pills in paper cup, then place inside crusher.



Cover with second cup to prevent cross contamination.



Squeeze handles with only enough pressure to break the pill. Move the handle up and down lightly while rotating the cups.



Remove cups. Now you are ready for next use.

## Hand-Held Pillcrusher

The Hand-held Pillcrusher has a die-cast body with an enamel finish. The unique handle design makes the crushing process effortless. Pills are crushed in patented bags. Each crusher is sold with 50 bags.



Uses 2 1/2" X 2" Sani-Safe Crush Bags

<b>Hand Held Pill Crusher</b>	104-696	\$20.76 ea.
-------------------------------	---------	-------------

**Pill Crushing Bags 2 1/2" X 2"**  
Roll of 100 104-656 \$6.41 ea.

**Pill Crushing Bags 4" X 2"**  
Roll of 100 104-661 \$6.41 ea.

### Ocelco's Pill Crushing Bags

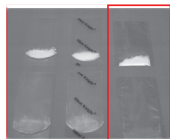

Lower Medicine Retention than any other pill crushing bag, giving you the entire pill you've crushed.

**Pill Counter with Spatula**  
104-210 \$9.80 ea.



**Pill Splitter**  
104-236 \$5.25 ea.

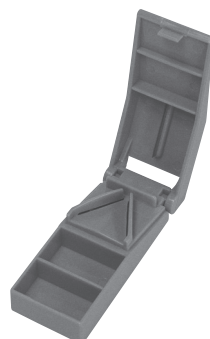

## Naugahyde Material



67 Dark Blue 68 Royal Blue 27 Burgundy 23 Mauve 82 Camel 96 Beige

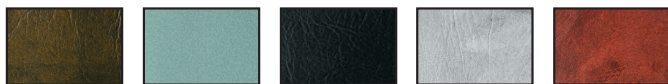

54 Dark Green 57 Jade 46 Black 44 Gray 83 Nutmeg

## Nylon Material



60 Royal Blue 29 Red 89 Dark Brown 59 Green 48 Black 93 White

## Mesh Material

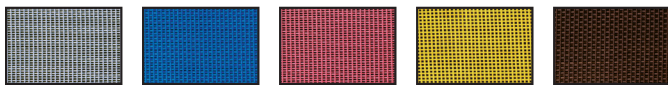

19 Light Blue 17 Royal Blue 21 Mauve 32 Yellow 88 Brown

## Webbing Material



18 Navy Blue 69 Royal Blue 22 Red 38 Yellow 52 Green 42 Black 92 White

## Shower/Commode Chair Material



23 Mauve 76 Salsa 53 Teal 82 Tan 64 Wedge Wood 58 Forest Green 68 Royal Blue



46 Black 02 Neon Pink 30 Yellow 67 Navy 56 Lime 20 Red 70 Orange

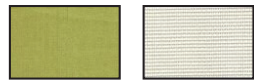

57 Garden Green 94 White

## Anti-Microbial Boardwalk Colors



01 Blue Moon 02 Buff 03 Cactus 04 Chablis 05 Chiffon 06 Graphite 07 Surf

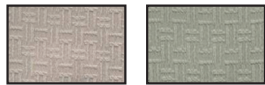

08 Taupe 09 Willow

## Stethoscope and Blood Pressure/Sphygmomanometers



46 Black 27 Burgundy 51 Hunter Green 44 Gray 38 Yellow 20 Red 18 Navy Blue



53 Teal 15 Lavender 25 Magenta 60 Royal Blue 70 Orange 10 Purple



# Wheelchair Parts

Presorted Standard  
U.S. Postage  
Paid  
Ripon, WI  
Permit No. 100



## Attention: Director of Maintenance

Shop Online [www.ocelco.com](http://www.ocelco.com) or call 800-328-5343.

We're The Friendly People

**LOG ON TODAY TO SAVE TIME AND MONEY WHEN YOU ORDER ONLINE**

Local 1-218-828-7788  
Toll Free 1-800-328-5343  
Fax 1-866-829-9744  
web [www.ocelco.com](http://www.ocelco.com)

1111 Industrial Park Road  
Brainerd, MN 56401

Serving Your Needs  
Since 1974

