

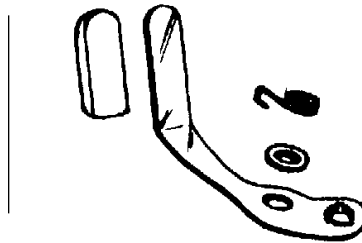

Invacare Complete \$9.00 ea.
Left 143-110
Right 143-120

Spring Only \$.95 ea.
Left 143-134
Right 143-135



Colson \$40.37 ea.
Left 143-310
Right 143-320

Spring Only \$9.00 ea.
Left 143-332
Right 143-333

Everest & Jennings



Complete \$4.95 ea.
Left 143-510
Right 143-520
Spring Only \$.95 ea.
Left 143-530
Right 143-531



143-503 \$8.94 ea.

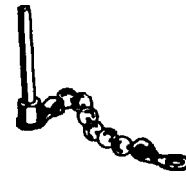

143-501 \$19.41 ea.

Legrest Release Levers

Everest & Jennings

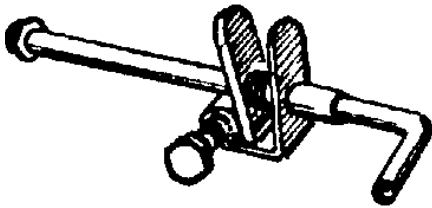

Release Lever 144-500 \$34.24 ea.

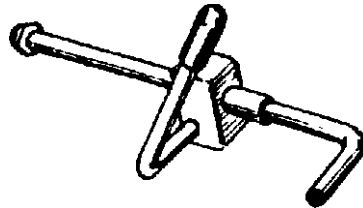

Adjustment Rod 144-501 \$9.95 ea.

Invacare



Complete Set 144-130 \$23.07 set

Theradyne

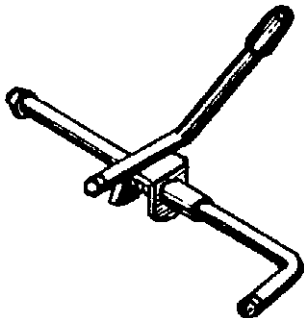

Release Lever \$25.56 ea.
Left 144-210
Right 144-220

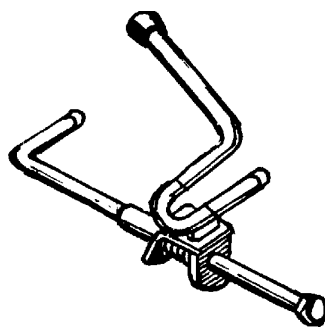

Release Lever \$22.35
Left, Disc.
Right, Limited Availability 144-221

Gendron

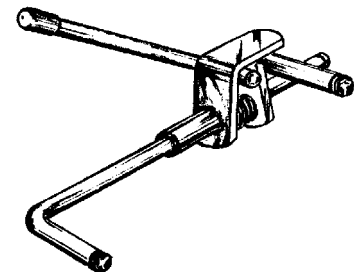

Release Lever \$39.11
Left 144-411
Right 144-421

Universal Calf Pads and Padded Covers

Plastic Calf Pads

145-1CL \$10.88 ea.

Available in Blue, Grey, Black or Brown

Padded Calf Pads

146-3CL Black Base \$13.90 ea.

Available in all colors below.

Padded Calf Pad Covers

Turn your plastic calf pad into a padded calf pad with this cover.

146-2CL \$4.95 ea.

Available in all colors below, except Mauve & Jade.

Fits:

Invacare
Everest & Jennings
Smith & Davis
Lumex

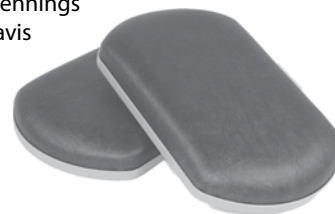

Colors for Padded Calf Pads Above: 67 Dark Blue, 68 Royal Blue, 64 Light Blue, 86 Walnut, 83 Nutmeg, 82 Camel, 23 Mauve, 26 Crimson, 27 Burgundy, 54 Cactus, 57 Jade, 96 Beige, 46 Black or 44 Grey **Color page 159**

Invacare Calf Pad Assembly

Fig.	Part #	Description	Price
	146-2CL	Calf Pad Cover Specify Color Above	\$6.45 ea.
B	164-480	Bolt	\$1.49 ea.
C	145-1CL	Calf Pad, Plastic	\$10.88 ea.
D	147-102	Pad Plate	\$4.31 ea.
	147-103	Swivel Bracket	\$18.78 ea.
F	147-104	Spring	\$6.48 ea.
G	147-105	Bushing	\$6.48 ea.
H	164-506	Nut	\$.23 ea.
I	147-106	Mounting Bracket Chrome	\$14.16 ea.
J	147-101	Spacer	\$6.23 ea.

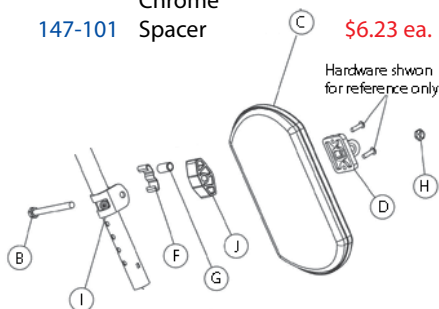

MRI Non-Magnetic Calf Pads

Padded Calf Pad for MRI Legrests

Hole Spacing: 2"

Choose Color

146-6CL \$28.72 ea.

Available in Burgundy (27) or Green (50)



Everest & Jennings Calf Pad Assembly

Fig.	Part #	Description	Price
A	146-1CL	Padded Calf Pad Specify Color Above	\$13.90 ea.
A	145-1CL	Plastic Calf Pad Blue, Grey or Cocoa	\$10.88 ea.
B	147-501	Plate w/Spring	\$2.44 ea.
C	147-502	Swivel Bracket	\$6.95 ea.
F	147-508	Spring Only	\$1.00 ea.

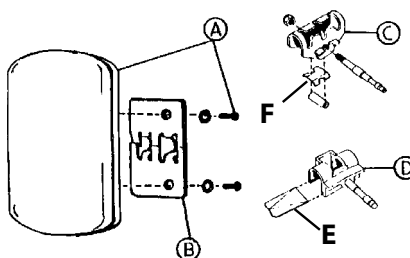

Theradyne or American Calf Pad Assembly

Fig.	Part #	Description	Price
A	164-507	Nuts	\$.23 ea.
B	147-202	Carriage Bolt	\$.23 ea.
C	147-203	Swivel Bracket	\$8.98 ea.
D	147-204	Grey Vibro	\$.95 ea.
E	147-205	Calf Pad Plate	Disc.
F	145-246	Calf Pad, Plastic	\$6.95 ea.
	146-2CL	Calf Pad Cover Specify Color Above	\$6.45 ea.

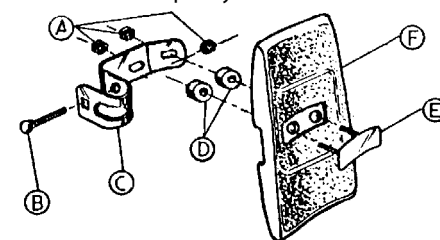

Gendron Calf Pad Assembly

Fig.	Part #	Description	Price
A	146-7CL	Calf Pad Padded Specify color below	\$29.95 ea.
B	147-413	Screw	\$.23 ea.
C	147-414	Lock Washer	\$.23 ea.
D	147-415	Pad Plate	\$23.11 ea.
E	147-416	Bushing	\$2.22 ea.
F	147-417	Swivel Bracket	\$13.46 ea.
G	147-418	Bushing	\$.95 ea.
H	147-419	Lock Nut	\$.23 ea.

Colors: 44 Grey, 46 Black, 68 Royal Blue, 86 Brown, 27 Burgundy

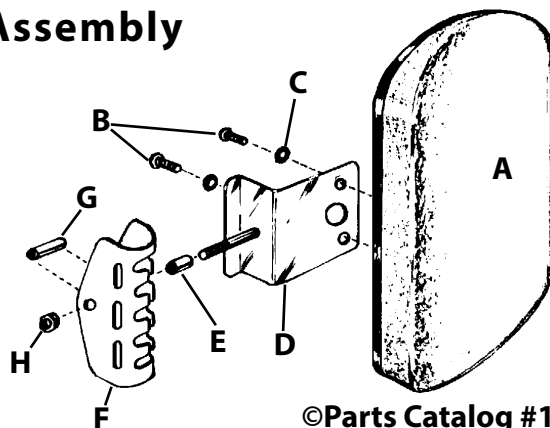

Footplates

Standard Footplate

For 7/8" tubing

148-100 Aluminum \$8.95 ea.

148-116 Plastic \$8.95 ea.

MRI Non-Magnetic Footplates

18" to 24" MRI Standard Chair

148-122 \$39.26 ea.

24" to 26" MRI Heavy Duty Chair

148-121 \$45.57 ea.



Extension Tube with Draw Bolt



148-111 \$8.75 ea.

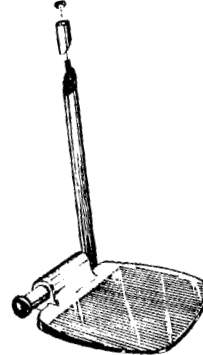

Standard Footplate with Extension Tube & Draw Bolt

With Out Heel Loops \$18.50 ea.

Left 148-105

Right 148-106

With Heel Loops \$19.50 ea.

Left 148-107

Right 148-108

Oversize Footplate

Black, 8 1/2" L x 7 3/4" W

For 7/8" tubing

148-101 Left side \$47.36 ea.

148-102 Right Side \$47.36 ea.

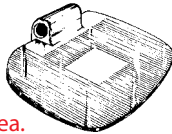

Black Footplate

For Drive Wheelchairs

148-120 Plastic \$17.86 ea.



Roller Bumper

149-103 \$3.95 ea.



MRI Non-Magnetic Roller Bumper, for HD Chairs only

Fits 3/4" I.D. tubing

149-151 \$16.58 ea.



Bumper

149-101 Grey

149-119 Black

\$.95 ea.



MRI Non-Magnetic Screw for MRI Foot / Legrest Rubber Bumper, Fits all MRI Chairs

149-153 \$8.42 ea.

Legrest Release Levers Cap

125-103 \$1.33 ea.



Black Rubber

Everest & Jennings Footrest & Legrest Draw Bolt

Adult 148-103

\$3.95 ea.

Junior 148-104

\$10.95 ea.

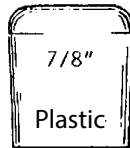

Tube Cap \$.95 ea.

Grey 125-105

Brown 125-100

Black 125-102



Tube Sleeve

149-102 \$3.95 ea.



Legrest Grip

Rubber

7/8" x 1/8" Black 120-106

\$6.23 ea.

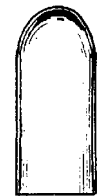
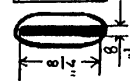

Legrest Grip

Rubber

1/2" x 1/8" Grey 120-105

\$1.95 ea.

1/2" x 1/8" Black 120-112

\$1.95 ea.

Footrest Hangers



E & J Camlock

Left 148-112

Right 148-113

Invacare Camlock

Left 148-114

Right 148-115



Foot & Legrest Clamp

3/4"-7/8" 149-107 \$2.95 ea.

7/8"-1" 149-120 \$3.45 ea.



Knob Adjuster

149-113 \$20.12 ea.

Damper



Grey Rubber

149-100 \$.95 ea.



MRI Tension "O" Ring, Fits all MRI Chairs

149-152 \$8.42 ea.

Spring Plastic

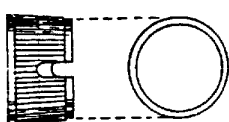

Old E&J

149-111 \$1.95 ea.

Spring Steel



149-112 \$.53 ea.

Spring Steel



Invacare

149-108 \$.95 ea.

Spring Steel

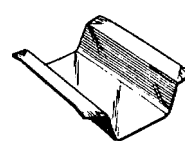

E&J

149-110 \$.95 ea.

Spring Steel



Gendron

149-109 \$1.65 ea.

Determine Your Footrest or Legrest Type

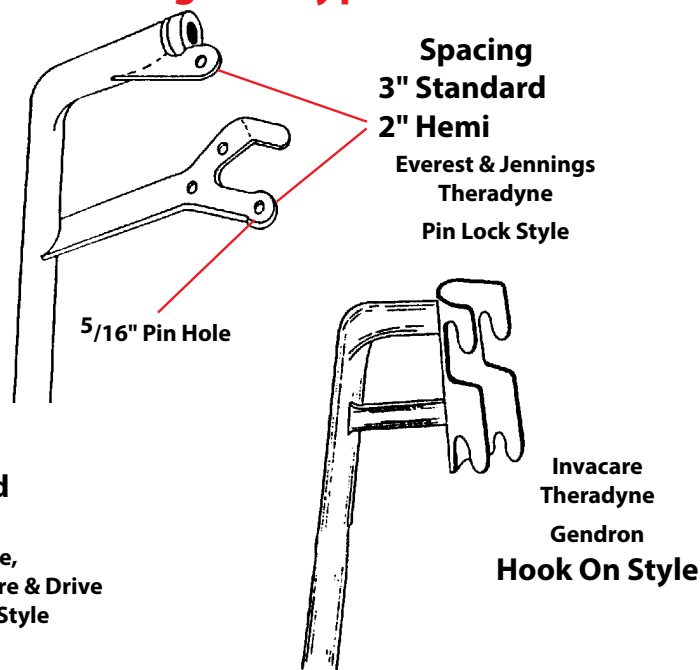
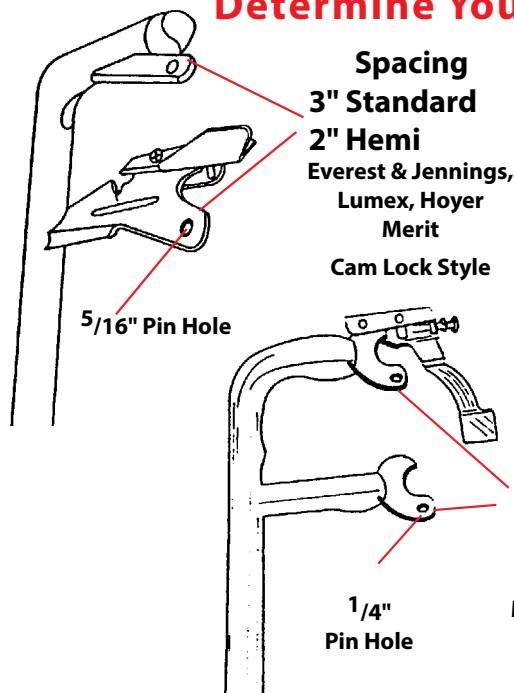

Front Rigging Locking Kits

Prevent removal and possible loss of your expensive swingaway footrests or legrests. Threadless end caps push onto the bottom pin and make it difficult to remove your front rigging. Clamp style, clamps onto the bottom pin by tightening the allen head screw, allen wrench included in this set.

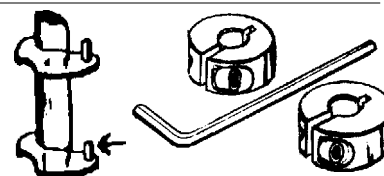

- Threadless End Caps
- 149-104 1/4" \$.75 ea.
 - 149-105 5/16" \$.75 ea.
 - 149-106 7/16"-1/2" \$2.11 ea.

- MRI Non-Magnetic Locking Kit**
 Clamp Locks 1/4" 149-154 \$24.72 pr.

- Clamp Locks
- 149-117 1/4" \$7.30 pr.
 - 149-118 5/16" \$7.30 pr.

Footrest & Legrest Adapters



Converts Invacare, Theradyne and Gendron hook on footrests or legrests, to Invacare swingaway Cam lock footrests or legrests

- 142-110-L Left \$10.40 ea.
- 142-110-R Right \$10.40 ea.



Converts Gendron hook on footrests or legrests, to Gendron swingaway Cam lock footrests or legrests

- 142-410-L Left \$19.26 ea.
- 142-410-R Right \$19.26 ea.

Heel and Toe Loops



- Econo Heel Loop 196-102 \$3.55
- Heel Loop 196-100-CL \$4.95
- Padded Heel Loop 196-101-CL \$6.70
- Toe Loop 196-200-CL \$5.35
- Padded Toe Loop 196-201-CL \$6.70



MRI Non-Magnetic Heel Loops

- 18" to 24" Wide MRI Standard Chairs Universal Fit 196-130 \$22.39
- 24" to 26" Wide MRI Heavy Duty Chairs Choose Side, L or R 196-131-X \$30.70



MRI Non-Magnetic Heel Loop and Footplate

- 18" to 24" Wide MRI Standard Chairs Choose Side, L or R 196-132-X \$50.57
- 24" to 26" Wide MRI Heavy Duty Chairs Choose Side, L or R 196-133-X \$49.10



Specify color from page 149

Footrest Pads

Specify color from page 149

Made with 1/2" foam. Attaches to footrests with velcro straps or metal hooks. Velcro style or hook on style are made for 18" wide chairs. Special sizes available upon request.

- Footrest Pad**
- Velcro 191-1CL \$27.37
 - Hooks 196-202-CL \$28.31

Front Rigging

Invacare Cam-Lock Swingaway Detachable Footrests

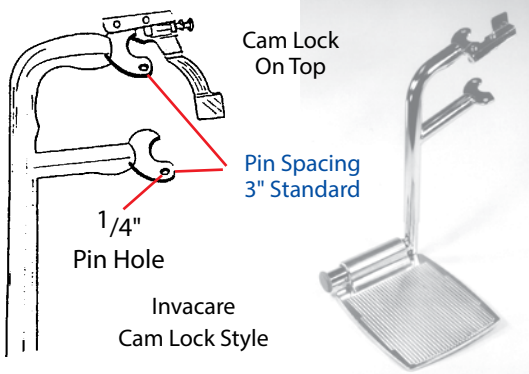

Standard

140-111	Left	Economy	Black Plastic Footplate	\$22.30 ea.
140-121	Right			\$22.30 ea.
140-110	Left	Deluxe	Silver Aluminum Footplate	\$22.30 ea.
140-120	Right			\$22.30 ea.
140-113	Left	Deluxe	Black Aluminum Footplate w/ Heel Loops	\$22.30 ea.
140-123	Right			\$22.30 ea.

To convert hook-on style chairs to accept swingaway footrests, see adapters on Page 41.

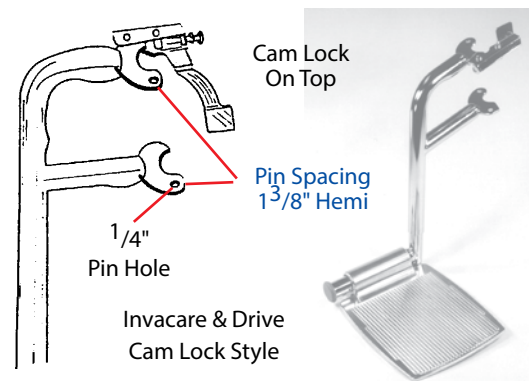

Hemi

140-114	Left	Economy	Black Plastic Footplate	\$22.30 ea.
140-124	Right			\$22.30 ea.
140-112	Left	Deluxe	Silver Aluminum Footplate	\$22.30 ea.
140-122	Right			\$22.30 ea.
140-115	Left	Deluxe	Black Aluminum Footplate w/ Heel Loops	\$29.95 ea.
140-125	Right			\$29.95 ea.

Gendron Cam-Lock Swingaway Detachable Footrests



Standard and Hemi
140-610 Left \$ 51.72 ea.
140-620 Right \$ 51.72 ea.

Hook-On Detachable Footrests

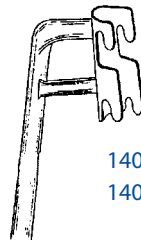

Invacare, Gendron & Theradyne

140-010 Left \$87.25 ea.
140-020 Right \$87.25 ea.



Do you have a hook-on style chair and want to convert it to detachable swingaway footrests?



Adapters convert Hook-on style chairs to accept Gendron swingaway cam-lock footrests. These brackets will fit Invacare, Gendron and Theradyne hook-on style chairs. Only Gendron Footrests will fit the adapters.

142-410-L Left \$19.26 ea.
142-410-R Right \$19.26 ea.

MRI Non-Magnetic Footrests

MRI Aluminum Footrests

Detachable Swing-Away with Heel Loops, Choose Left or Right for Aluminum Wheelchairs
140-700-X \$109.00 ea.



MRI Non-Magnetic Footrests

Detachable Swing-Away with Heel Loops, Choose Left or Right
18" to 20" Wide Chairs, Standard
140-701-X \$99.68 ea.
22" to 24" Wide Chairs, Standard
140-702-X \$166.09 ea.
24" to 26" Wide Chairs, Heavy Duty
140-703-X \$232.42 ea.



E&J, Lumex, Hoyer, Merit & New Theradyne Cam-Lock Swingaway Detachable Footrests

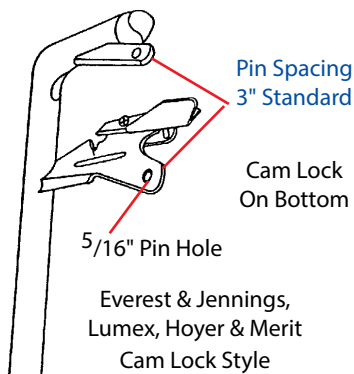

		Standard		
140-510	Left	Economy	Standard Release Lever	\$22.30 ea.
140-520	Right		Silver Aluminum Footplate	\$22.30 ea.
140-512	Left	Deluxe	Standard Release Lever	\$29.95 ea.
140-522	Right		Silver Aluminum Footplate w/ Heel Loops	\$29.95 ea.

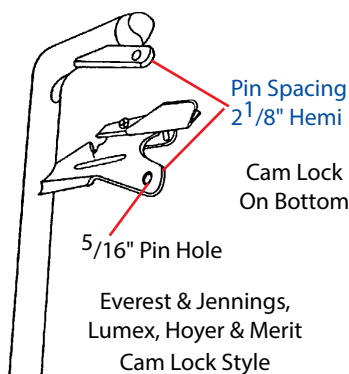

		Hemi		
140-514	Left	Economy	Standard Release Lever	\$22.30 ea.
140-524	Right		Silver Aluminum Footplate	\$22.30 ea.
140-518	Left	Deluxe	Standard Release Lever	\$29.95 ea.
140-528	Right		Silver Aluminum Footplate w/ Heel Loops	\$29.95 ea.

Pin Lock Swingaway Detachable Footrests Everest & Jennings

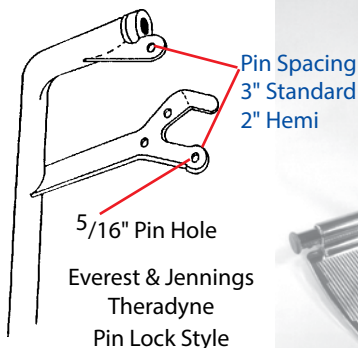

140-511	Standard Left	\$35.00 ea.
140-521	Standard Right	\$35.00 ea.
140-516	Hemi Left	\$40.00 ea.
140-526	Hemi Right	\$40.00 ea.

Old Theradyne

140-511	Standard Left	\$35.00 ea.
140-521	Standard Right	\$35.00 ea.
140-515	Hemi Left	Disc.
140-525	Hemi Right	Disc.

MRI Non-Magnetic Legrests

MRI Non-Magnetic Legrests

Detachable Swing-Away with Heel Loops and Calf Pads
Choose Side (X): (L)Left or (R)Right
Choose Color (CL): Burgundy -27 or Green - 50

18" to 24" Wide Chairs, Standard
140-750-X-CL \$258.98 ea.
24" to 26" Wide Chairs, Heavy Duty
140-751-X-CL \$278.91 ea.



Visit our New Online Store

www.WheelchairParts.com

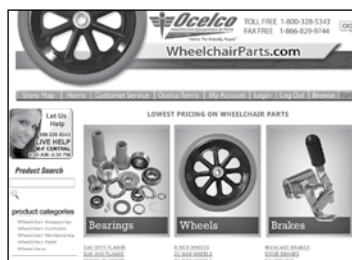

Order from
WheelchairParts.com
Discount Code PARTS

©Parts Catalog #1050