

Bearings

Old Style Everest & Jennings Bearings

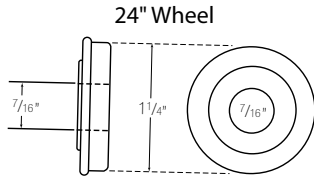

110-100 \$2.95 ea.

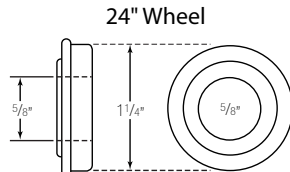

110-101 \$3.95 ea.

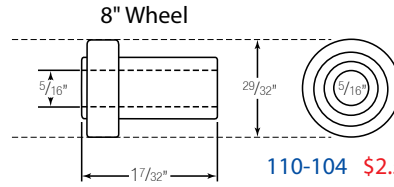

110-104 \$2.59 ea.

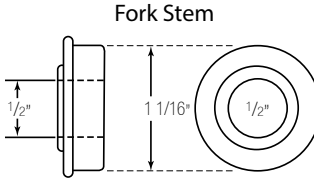

115-117 \$2.95 ea.

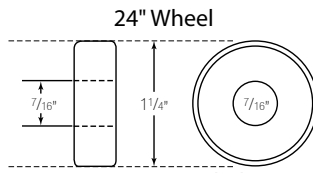

110-106 \$4.95 ea.

Bearing Sets

Bearing set for chair with 7/16" axle on 24" wheel

- 2 ea. # 110-100 24" Wheel
- 2 ea. # 110-104 8" Wheel
- 2 ea. # 115-117 Fork Stem

118-100 \$18.00 set

Bearing set for chair with 5/8" axle on 24" wheel

- 2 ea. # 110-101 24" Wheel
- 2 ea. # 110-104 8" Wheel
- 2 ea. # 115-117 Fork Stem

118-101 \$21.00 set

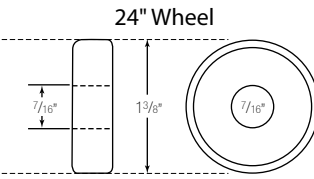

110-102 \$4.49 ea.

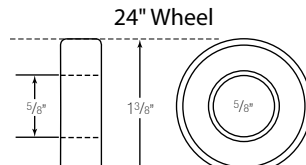

110-103 \$4.49 ea.

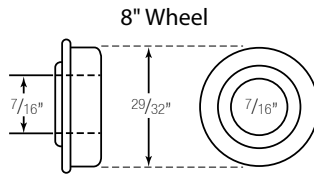

115-113 \$3.55 ea.

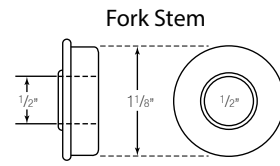

115-109 \$1.95 ea.

Invacare Bearings

Bearing Sets

Bearing set for chair with 7/16" axle on 24" wheel

- 2 ea. # 110-102 24" Wheel
- 2 ea. # 115-113 8" Wheel
- 2 ea. # 115-109 Fork Stem

118-102 \$20.00 set

Bearing set for chair with 5/8" axle on 24" wheel

- 2 ea. # 110-103 24" Wheel
- 2 ea. # 115-113 8" Wheel
- 2 ea. # 115-109 Fork Stem

118-103 \$20.00 set

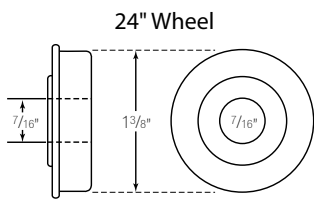

115-103 \$2.95 ea.

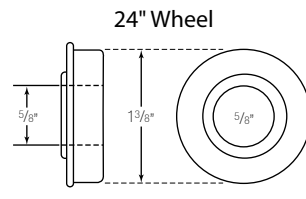

115-105 \$2.95 ea.

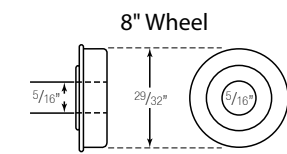

115-112 \$2.95 ea.

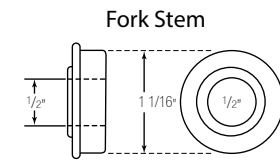

115-117 \$2.95 ea.

Theradyne Bearings

Bearing Sets

Bearing set for chair with 1/2" axle on 24" wheel

- 2 ea. 115-104 24" Wheel
- 2 ea. 115-113 8" Wheel
- 2 ea. 115-117 Fork Stem

118-106 \$18.00 set

Bearing set for chair with 7/16" axle on 24" wheel

- 2 ea. 115-103 24" Wheel
- 2 ea. 115-113 8" Wheel
- 2 ea. 115-117 Fork Stem

118-104 \$18.00 set

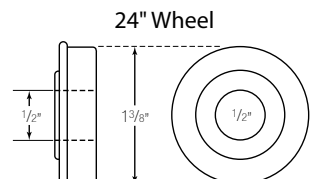

115-104 \$3.10 ea.

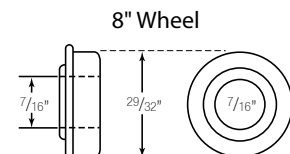

115-113 \$3.55 ea.

Bearing set for chair with 5/8" axle on 24" wheel

- 2 ea. 115-105 24" Wheel
- 2 ea. 115-113 8" Wheel
- 2 ea. 115-117 Fork Stem

118-105 \$18.00 set

Toll Free 800-328-5343

Fax Free 866-829-9744

www.ocelco.com

Metric/Medline Bearings

Medline, Drive 8" Wheel
 8mm x 22mm

Set includes 2 bearings and 1 bushing.
 Sealed outside

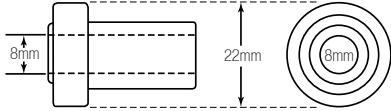

#112-112 w/bushing \$19.63 set

Medline 24" Wheel without flange
 12mm x 37mm

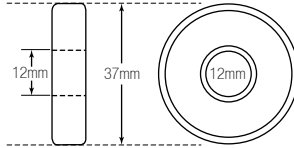

Precision Sealed outside & inside
 #112-110 12mm \$3.95 ea.
 #112-111 15mm \$12.06 ea.

Theradyne, Invacare & some
 Gendron 8" Wheel

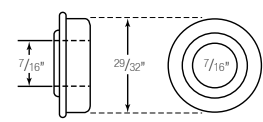

7/16" x 29/32" with a 1 1/16" flange
 #115-113 Deluxe \$3.55 ea.
 #115-130 Econo \$2.80 ea.

Medline, New Everest & Jennings 8" Wheel
 8mm x 22mm

Precision Sealed outside & inside

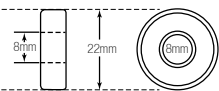

#112-102 w/o bushing \$3.25 ea.

Drive Fork Stem
 13mm x 28mm

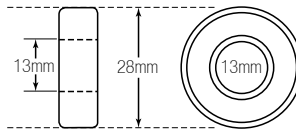

#112-114 w/o flange \$3.55 ea.
 #112-113 with flange \$3.10 ea.

Theradyne 8" Wheel

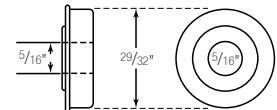

5/16" x 29/32" with 1" flange
 #115-112 \$2.95 ea.

Drive Wheel Bearing without flange
 11mm x 23mm Cruiser III

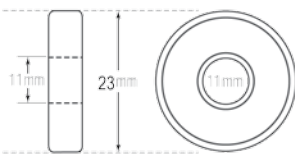

#112-115 \$3.40 ea.

Quickie Bearings

8" Wheel

Precision Sealed outside & inside

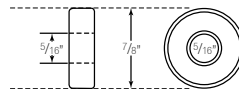

5/16" x 7/8"
 #112-102 \$3.25 ea.

Theradyne & some
 Gendron 24" Wheel

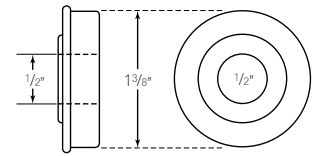

1/2" x 1 3/8" with 1 1/2" flange
 #115-104 \$3.10 ea.

Drive 24" Wheel without flange
 11mm x 35mm Cruiser and Silver Sport

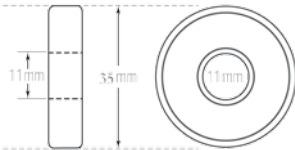

#112-106 \$5.54 ea.

Fork Stem & 24" Wheel
 Precision Sealed outside & inside

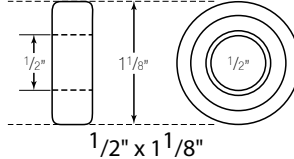

1/2" x 1 1/8"
 #115-110 \$3.95 ea.

Theradyne 24" Wheel

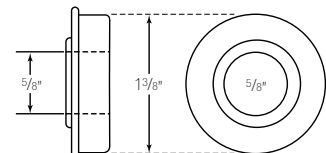

5/8" x 1 3/8" with 1 1/2" flange
 #115-105 \$2.95 ea.

Medline, Drive & New Everest & Jennings
 Fork Stem

12mm x 28mm

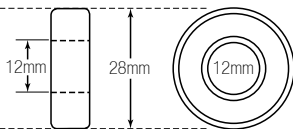

Precision Sealed outside & inside
 #112-101 w/o flange \$3.95 ea.
 #112-104 with flange \$12.00 ea.

Theradyne &
 Everest & Jennings Fork Stem

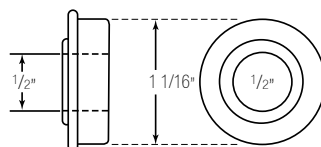

1/2" x 1 1/16" with 1 3/16" flange
 #115-117 \$2.95 ea.

Theradyne 24" Wheel

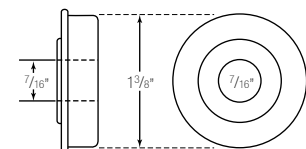

7/16" x 1 3/8" with 1 1/2" flange
 #115-103 \$2.95 ea.

12mm x 32mm
 Precision Sealed outside & inside

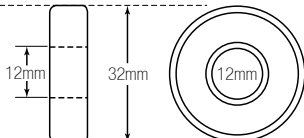

#112-100 w/o flange \$3.95 ea.
 #112-103 with flange \$11.30 ea.

Colson 8" Wheel, Invacare Fork Stem,
 and some Gendron Fork Stems

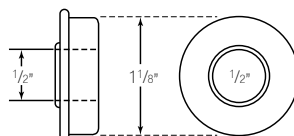

1/2" x 1 1/8" with a 1 1/4" flange
 #115-109 \$1.95 ea.

Invacare 24" Wheel

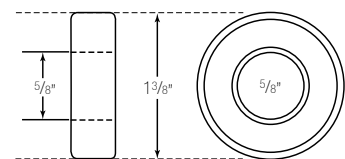

5/8" x 1 3/8"
 #110-103 \$4.49 ea.

Invacare 24" Wheel

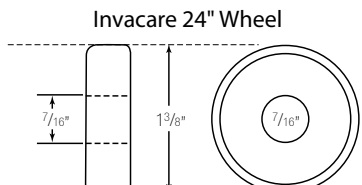

$7/16" \times 1 3/8"$
#110-102 \$4.49 ea.

$1/4" \times 29/32"$ with a 1" flange

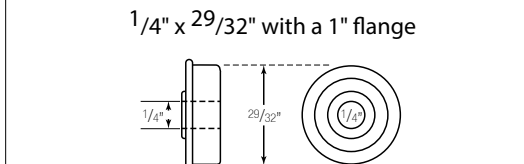

#115-115 \$2.75 ea.

$5/8" \times 1 1/8"$

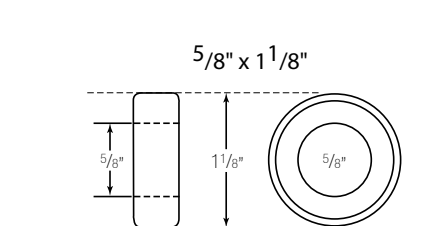

#115-111 \$3.04 ea.

Old Everest & Jennings 8" Wheel

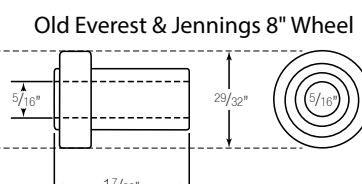

$5/16" \times 29/32"$
#110-104 \$2.59 ea.

$7/16" \times 29/32"$
Precision Sealed

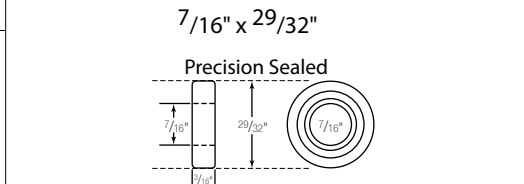

#115-114 3/16" Thick, std \$2.95 ea.
#115-125 5/16" Thick \$2.95 ea.

$1/2" \times 1 1/4"$ with a $1 3/8"$ flange

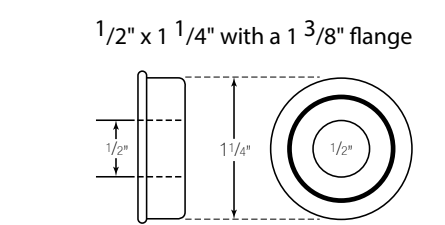

#115-101 \$7.30 ea.

Old Everest & Jennings 24" Wheel
Precision Sealed.

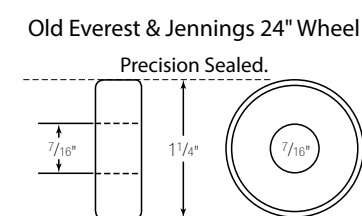

$7/16" \times 1 1/4"$ with out flange
#110-106 \$4.95 ea.

$1/2" \times 1"$

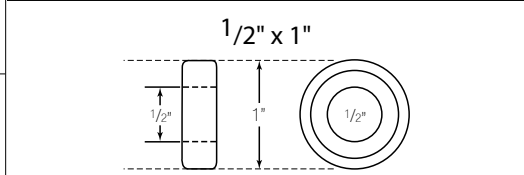

#115-116 \$3.35 ea.

$5/8" \times 1 1/4"$ with a $1 11/32"$ flange

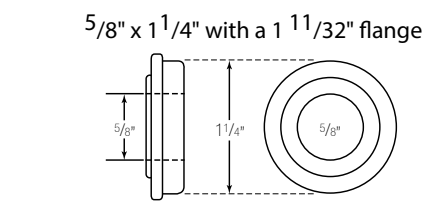

#115-102 \$8.18 ea.

Everest & Jennings 24" Wheel

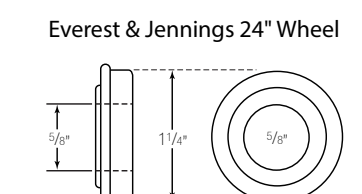

$5/8" \times 1 1/4"$ with a $1 3/8"$ flange
#110-101 \$3.95 ea.

$7/16" \times 1 1/16"$ with $1 3/16"$ flange

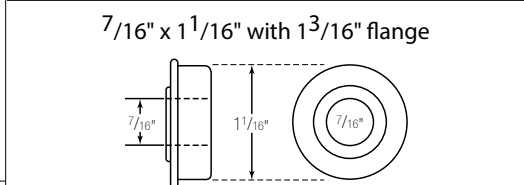

#115-119 \$6.08 ea.

$1/2" \times 1 3/8"$

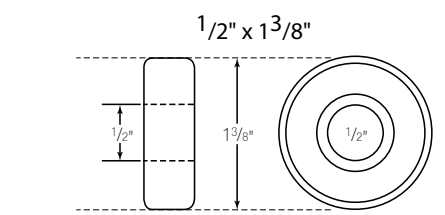

#110-105 \$4.95 ea.

Everest & Jennings 24" Wheel

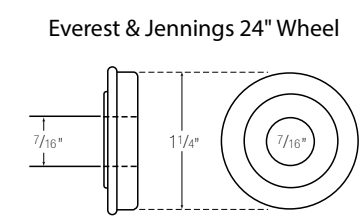

$7/16" \times 1 1/4"$ with a $1 3/8"$ flange
#110-100 \$2.95 ea.

Plastic Bearing (Not MRI Safe)

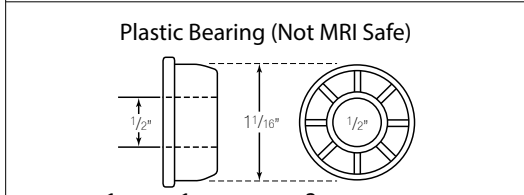

$1/2" \times 1 1/16"$ with $1 3/16"$ flange
#115-118 \$4.96 ea.

$5/8" \times 1 1/2"$ with a $1 5/8"$ flange

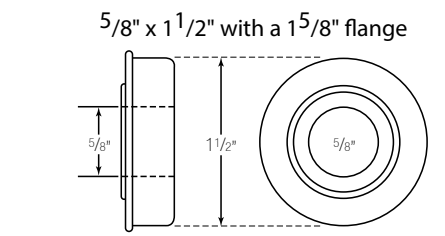

#115-122 \$10.52 ea.

$7/16" \times 7/8"$

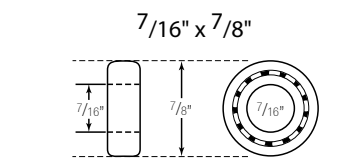

#115-121 \$5.52 ea.

$7/16" \times 1 1/8"$

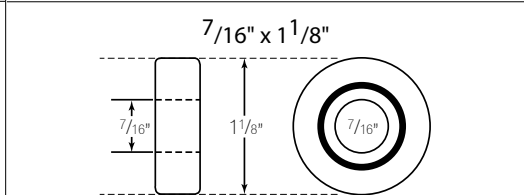

#115-108 \$3.55 ea.

$1" \times 2"$

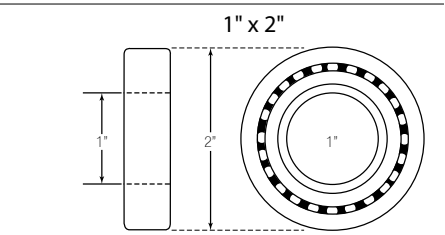

#115-123 \$8.95 ea.

$7/16" \times 1 1/8"$ with a $1 1/4"$ flange

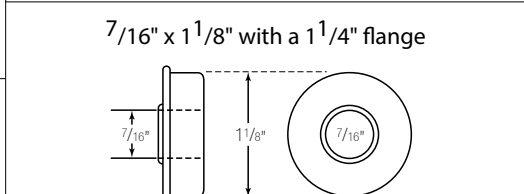

#115-107 \$2.70 ea.

Bearing Cone

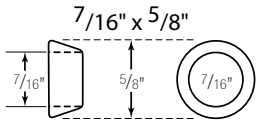

116-100 \$3.95 ea.

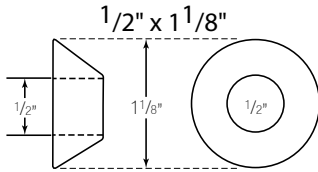

116-102 \$2.95 ea.

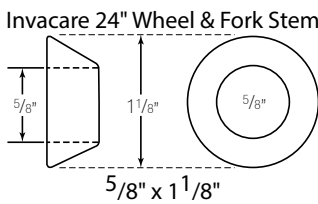

116-103 \$2.95 ea.

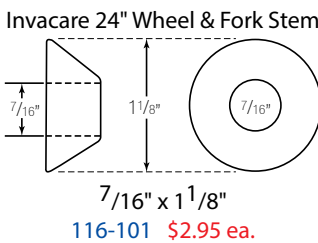

116-101 \$2.95 ea.



Felt Washer 5/8" I.D.
117-100 \$3.33 ea.



Nylon White Washer
117-110 \$.23 ea.

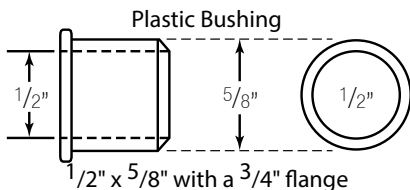

119-100 \$5.80 ea.

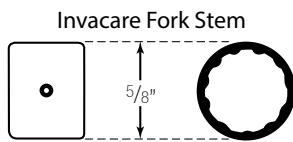

Needle Bearing
113-100 \$5.86 ea.

Ball Bearings

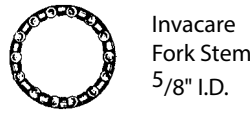

111-100 \$2.95 ea.



111-101 \$2.95 ea.



111-102 \$2.95 ea.

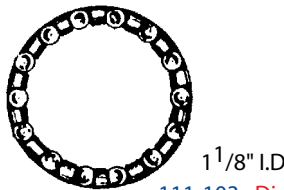

111-103 Disc.

Thrust Washers

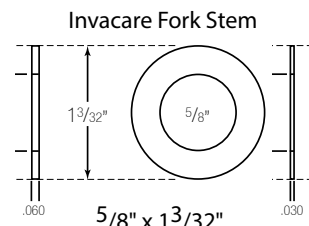

117-101 .060 thick \$1.10 ea.
117-102 .030 thick \$1.10 ea.

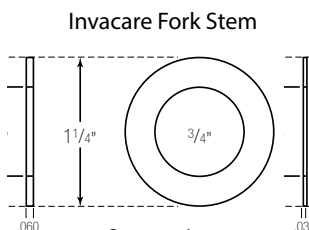

117-103 .060 thick \$1.10 ea.
117-104 .030 thick \$1.10 ea.

Plastic Bearings used on MRI Wheelchairs or Pool Chairs



MRI Fork/Caster Stem with 1 1/2" Flange
1/2" ID x 1 1/16" OD
115-128 \$13.52 ea.



MRI 8" x 1" Front Wheel with 5/16" axle
18" to 24" Chair
5/16" ID x 29/32" OD
115-129 \$9.00 ea.
MRI 8" x 2" Front Wheel
24" to 26" HeavyDuty Chair
5/16" ID x 7/8" OD
115-131 \$14.20 ea.



MRI Rear Wheel with 1 3/8" Flange
18" and 20" Chair
7/16" ID x 1 1/4" OD
115-127 \$9.50 ea.
22" and 24" Chair (not 24" HeavyDuty)
5/8" ID x 1 1/4" OD
115-126 \$9.50 ea.



MRI Rear Wheel with 1 1/4" Flange and 1 3/8" Flange
24" and 26" Wide Heavy Duty Chairs
5/8" ID x 1 1/16" OD
115-106 \$15.56 ea.



MRI Rear Wheel, Ceramic Ball Bearing with 1 3/8" Flange
Heavy Duty Chair
5/8" ID x 1 1/4" OD
115-132 \$35.43 ea.

Thrust Bearings

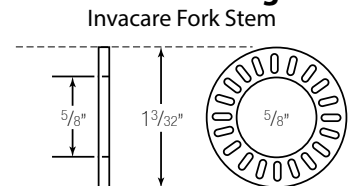

113-101 \$2.95 ea.

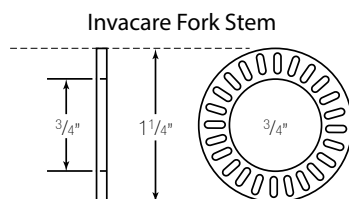

113-102 \$3.29 ea.

Invacare Bearing Housings

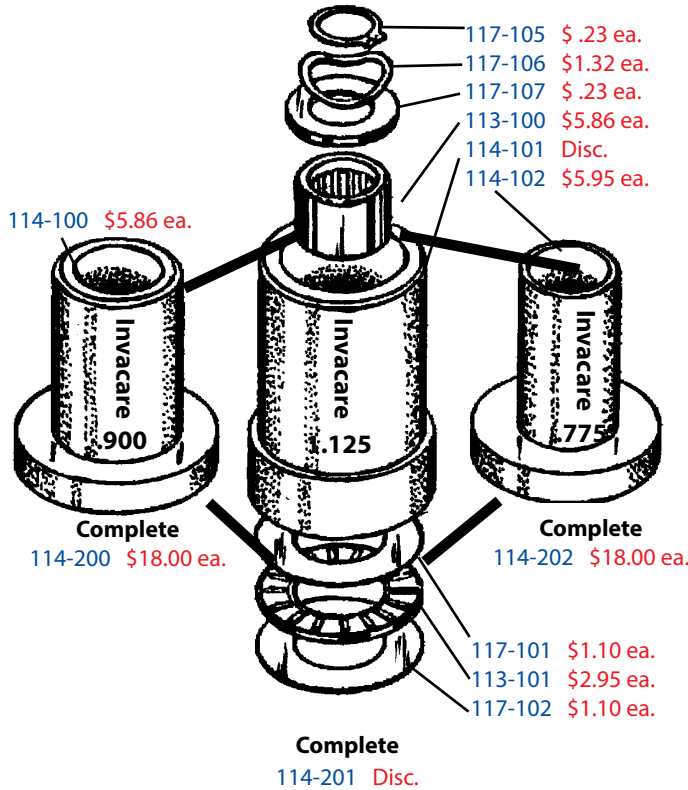

117-105 \$.23 ea.
 117-106 \$1.32 ea.
 117-107 \$.23 ea.
 113-100 \$5.86 ea.
 114-101 Disc.
 114-102 \$5.95 ea.

114-100 \$5.86 ea.
Complete
 114-200 \$18.00 ea.

114-106 \$9.82 ea.
 114-107 \$12.78 ea.
 115-105 \$2.95 ea.

Complete
 114-202 \$18.00 ea.

117-101 \$1.10 ea.
 113-101 \$2.95 ea.
 117-102 \$1.10 ea.

Complete
 114-201 Disc.

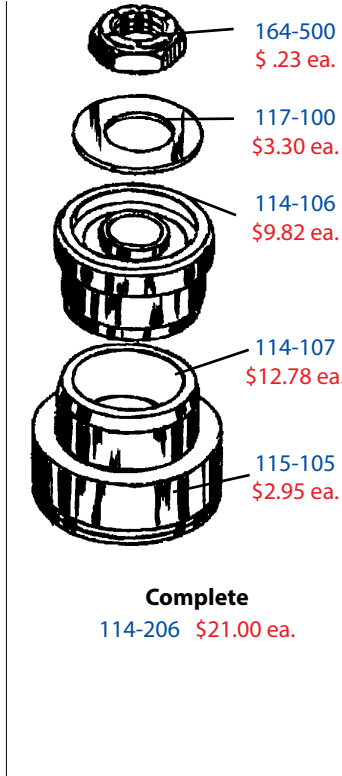

164-500 \$.23 ea.
 117-100 \$3.30 ea.
 114-106 \$9.82 ea.
 114-107 \$12.78 ea.
 115-105 \$2.95 ea.

Complete
 114-206 \$21.00 ea.

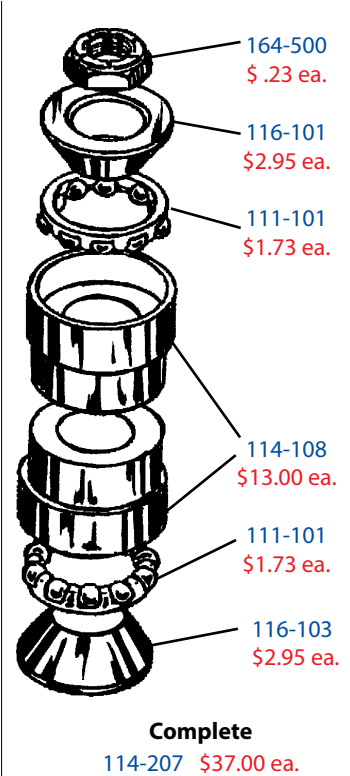

164-500 \$.23 ea.
 116-101 \$2.95 ea.
 111-101 \$1.73 ea.
 114-108 \$13.00 ea.
 111-101 \$1.73 ea.
 116-103 \$2.95 ea.

Complete
 114-207 \$37.00 ea.

Invacare Bearing Housing

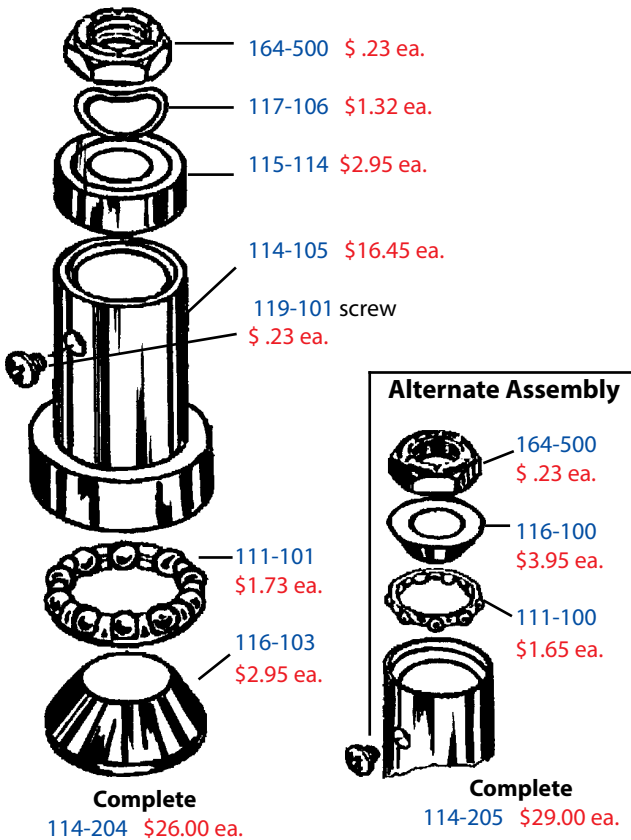

164-500 \$.23 ea.
 117-106 \$1.32 ea.
 115-114 \$2.95 ea.
 114-105 \$16.45 ea.
 119-101 screw \$.23 ea.

111-101 \$1.73 ea.
 116-103 \$2.95 ea.

Complete
 114-204 \$26.00 ea.

Alternate Assembly

164-500 \$.23 ea.
 116-100 \$3.95 ea.
 111-100 \$1.65 ea.

Complete
 114-205 \$29.00 ea.

Theradyne Bearing Housing

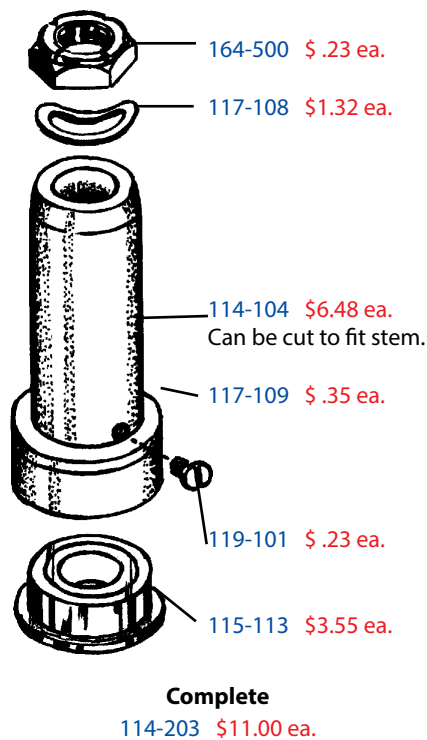

164-500 \$.23 ea.
 117-108 \$1.32 ea.
 114-104 \$6.48 ea.
 Can be cut to fit stem.
 117-109 \$.35 ea.
 119-101 \$.23 ea.
 115-113 \$3.55 ea.

Complete
 114-203 \$11.00 ea.

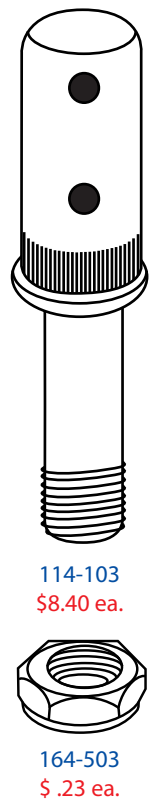

114-103 \$8.40 ea.
 164-503 \$.23 ea.