

Invacare Most Common Brakes Chrome Finish

For Fixed Arm Chair \$15.95 ea.
Left or Right, Specify 151-111-SD

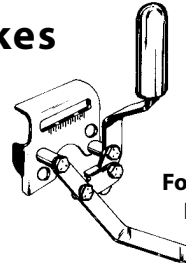

For Detachable Arm Chair \$15.95 ea.
Left or Right, Specify 151-121-SD

Other Invacare Brakes Specify Left or Right when Ordering Brakes.

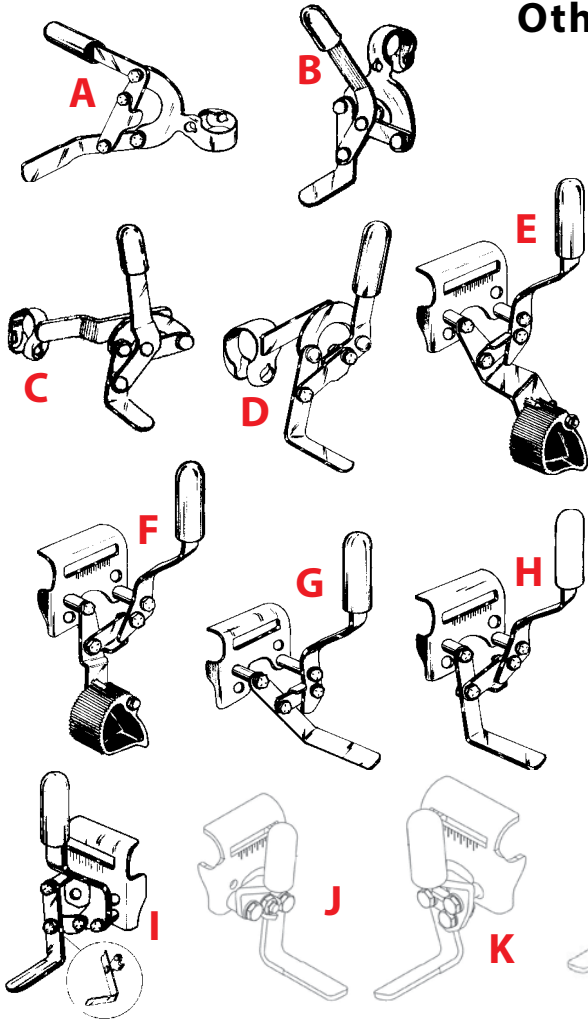

Part #	Finish	Arm Style	Locking	Price
A 151-461-SD	Chrome	Detach Arm	Push To Lock	\$47.66 ea.
B 151-311-SD	Chrome	Fixed Arm	Push To Lock	\$18.95 ea.
C 151-021-SD	Chrome	Detach Arm	Push To Lock	\$19.30 ea.
151-463-SD	Chrome	Detach Arm	Pull To Lock	\$47.64 ea.
D 151-401-SD	Chrome	Fixed Arm	Pull To Lock	\$47.64 ea.
E 151-411-SD	Chrome	Fixed Arm	Push To Lock	\$47.64 ea.
151-413-SD	Chrome	Detach Arm	Push To Lock	\$47.64 ea.
F 151-415-SD	Chrome	Fixed Arm	Pull To Lock	\$47.64 ea.
151-417-SD	Chrome	Detach Arm	Pull To Lock	\$47.64 ea.
G 151-111-SD	Chrome	Fixed Arm	Push To Lock	\$15.95 ea.
151-431-SD	Black	Fixed Arm	Push To Lock	\$47.64 ea.
151-433-SD	Chrome	Detach Arm	Push To Lock	\$27.89ea.
151-435-SD	Black	Detach Arm	Push To Lock	\$47.64 ea.
H 151-441-SD	Chrome	Fixed Arm	Pull To Lock	\$47.64 ea.
151-443-SD	Black	Fixed Arm	Pull To Lock	\$47.66 ea.
151-445-SD	Chrome	Detach Arm	Pull To Lock	\$27.89 ea.
151-447-SD	Black	Detach Arm	Pull To Lock	\$47.64 ea.
I 151-451-SD	Chrome	Detach Arm	Pull To Lock	\$47.64 ea.
J 151-134-SD	Chrome	Det. Flip Back Arm	Push To Lock	\$33.48 ea.
K 151-136-SD	Chrome	Det. Flip Back Arm	Pull To Lock	\$31.48 ea.
L 151-138-SD	Chrome	Recliner		\$47.64 ea.
M 151-130-SD	Black	Hemi, Disk	Pull To Lock	\$49.83 ea.
151-132-SD	Black	Standard, Disk	Push To Lock	\$49.83 ea.

If the part you are looking for is not illustrated or you can not find what you need, let us help!

Call toll free 1-800-328-5343

Universal Wheelchair Brake Extensions

Features:

- > Available in three lengths
- > Available in two slot sizes
- > Available with or without elastic cord

Elastic Cord

The elastic cord connects the extension to the brake. This helps to hold the extension on the brake.



A. Without Elastic Cord

- 6" Extension with 1/8" Slot Size \$4.95
- 6" Extension with 3/16" Slot Size 154-105
- 8" Extension with 1/8" Slot Size 154-101
- 8" Extension with 3/16" Slot Size 154-104
- 10" Extension with 1/8" Slot Size 154-100
- 10" Extension with 3/16" Slot Size 154-103

B. With Elastic Cord

- 6" Extension with 1/8" Slot Size \$7.95
- 6" Extension with 3/16" Slot Size 154-108
- 6" Extension with 3/16" Slot Size 154-111
- 8" Extension with 1/8" Slot Size 154-107
- 8" Extension with 3/16" Slot Size 154-110
- 10" Extension with 1/8" Slot Size 154-106
- 10" Extension with 3/16" Slot Size 154-109

Quickie Wheelchair Brake Extensions



Brake Extension \$33.83 pr.
6" Extension 154-200

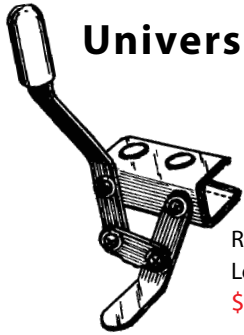

Universal Strap Mount Brake

Strap 159-100 \$4.95 ea.
Comes with attaching hardware

Right 153-001-R
Left 153-001-L
\$11.95 ea.

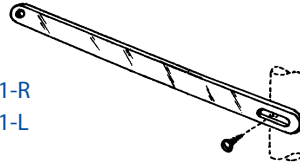

Universal Strap Mount Brake

Set

SAVE

Set Includes:
1 ea. 153-001-R Right Brake
1 ea. 153-001-L Left Brake
2 ea. Mounting Straps
All attaching hardware
153-010 \$29.95 Set

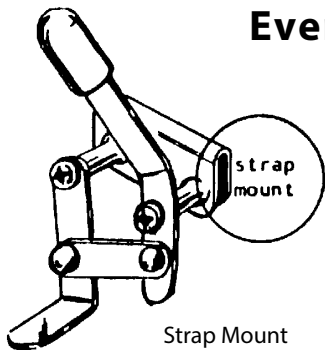
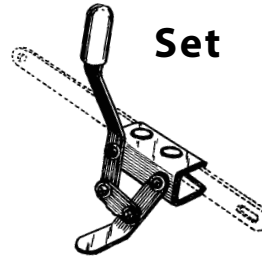

Everest & Jennings

Bar Mount \$11.95 ea.
Fixed Arm, Right 150-011-R
Fixed Arm, Left 150-011-L
Detach Arm, Right 150-021-R
Detach Arm, Left 150-021-L
Strap Mount \$11.55 ea.
Right 150-111-R
Left 150-111-L

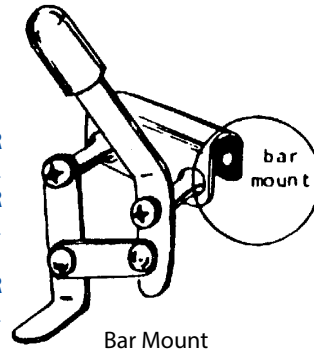

Strap Mount

Bar Mount

Medline



Vertical Bolt for K4 (shown) 151-001 \$66.28 pr.
Horizontal Bolt (not shown) 151-002 \$74.19 pr.

Quickie Brakes

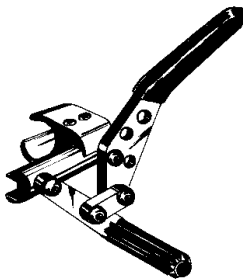

Left 153-201-L
Right 153-201-R
\$29.95 ea.

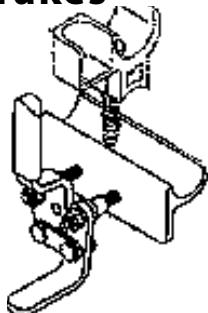

Breezy 500/510/2/600
Push-To-Lock 153-203
\$85.50 pr.

Theradyne

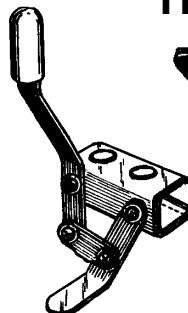

Left 153-001-L
Right 153-001-R
\$11.95 ea.

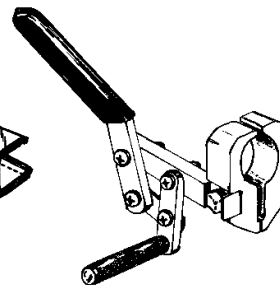

Left 153-101-L
Right 153-101-R
\$29.72 ea.

MRI Non-Magnetic Wheelchair Brake

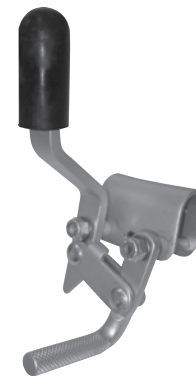

made with non-magnetic compents to be used on MRI compatible wheelchairs

Left 150-031-L
Right 150-031-R
\$42.11 ea.

Gendron

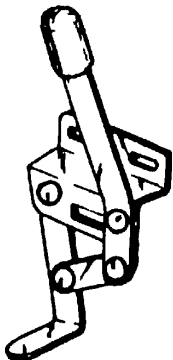

152-001-R Right
152-001-L Left
Disc.

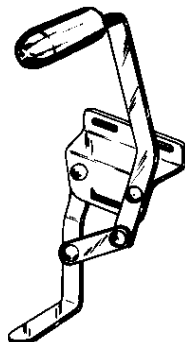

152-101-R Right
152-101-L Left
Disc.



152-201-R Right
152-201-L Left
\$13.95 ea.

Wheel Lock Shoe Spacer

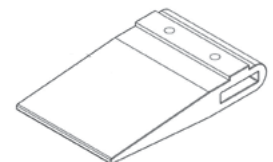

Includes hardware



154-114 1⁴⁵/₆₄" Long \$13.72 ea.
154-115 2⁷/₁₆" Long \$17.48 ea.

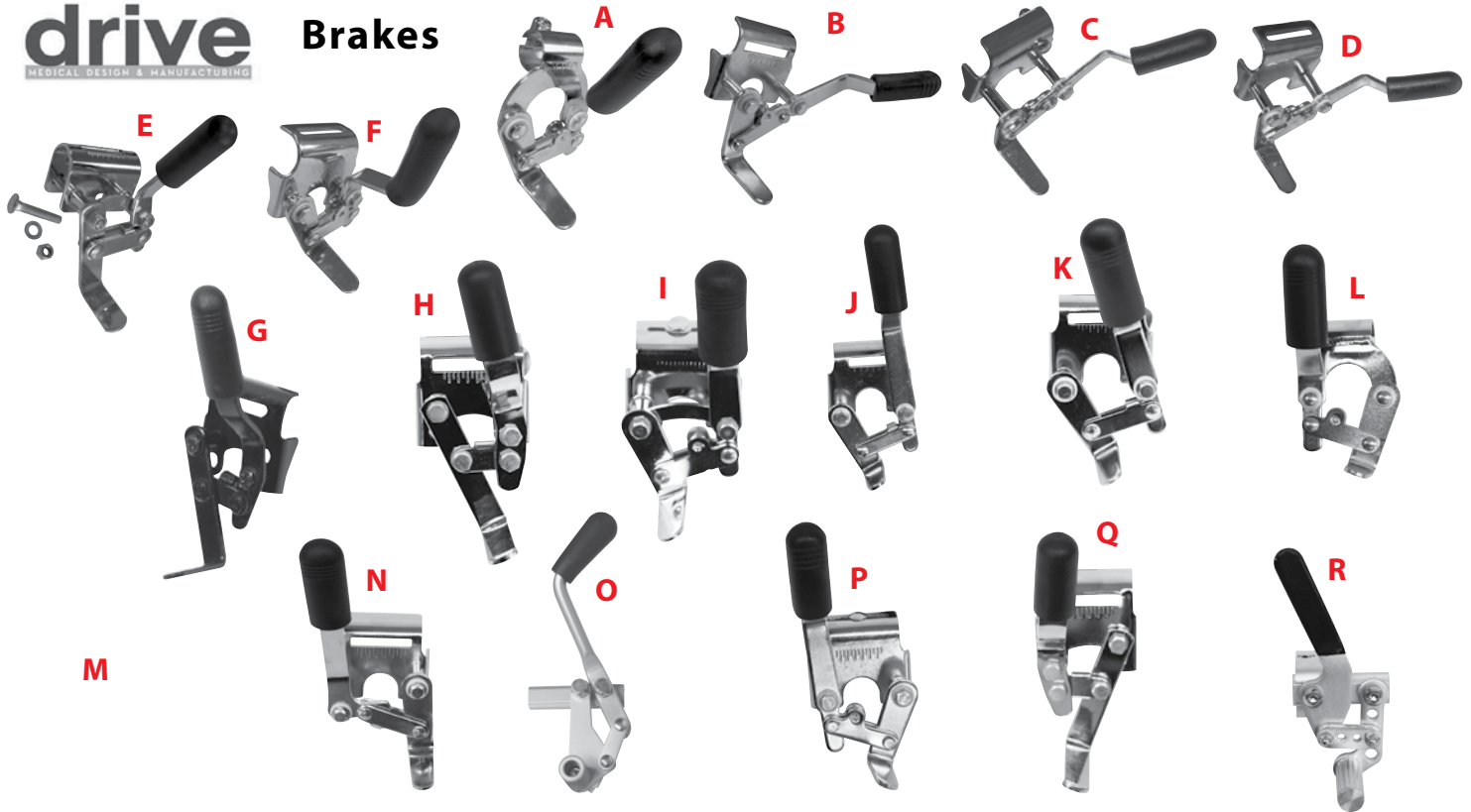

Brakes



Specify Left or Right when Ordering Brakes (determine left or right when sitting in chair)

	Part #	Fits Wheelchairs	Arm Style	Locking	Price	
	A	151-129-SD	Winnie	Fixed Arm	Push To Lock	\$17.76 ea.
	B	151-124-SD	Winnie & Sentra HD	Detach Arm	Push To Lock	\$14.10 ea.
	C	151-123-SD	Sentra EC (side mount)	Detach Arm	Push To Lock	\$14.10 ea.
	D	151-125-SD	Sentra Plus, Cirrus III & Astaire	Detach Arm	Push To Lock	\$14.10 ea.
	E	151-126-SD	Cirrus IV	Detach Arm	Push To Lock	\$21.15 ea.
	F	151-127-SD	Viper & Viper Plus (top mount)	Slope Arm	Push To Lock	\$14.10 ea.
	G	151-110-SD	Silver Sport I, Silver Sport II & Cruiser III	Detach Arm	Push To Lock	\$14.10 ea.
	H	151-140-SD	Sentra EC (side mount)	Fixed Arm	Push To Lock	\$14.10 ea.
	I	151-142-SD	Sentra HD EC Extra Wide (top mount)	Detach Arm	Push To Lock	\$14.10 ea.
	J	151-144-SD	Sentra 26", 28" & 30" Wide Chairs (side mount)	Detach Arm	Push To Lock	\$14.10 ea.
	K	151-146-SD	Winnie (side mount)	Detach Arm	Push To Lock	\$14.10 ea.
	L	151-148-SD	Winnie (side mount)	Fixed Arm	Push To Lock	\$14.10 ea.
	M	151-150-SD	Winnie II (top mount) Extended Back	Fixed Arm	Push To Lock	\$23.50 ea.
	N	151-152-SD	Viper (non-slope arms, top mount) Not 12" or 14" chairs	Flip Back Arm	Push To Lock	\$14.10 ea.
	O	151-154-SD	Viper (non-slope arms, top mount) ONLY 12" or 14" chairs	Flip Back Arm	Push To Lock	\$18.78 ea.
	P	151-156-SD	Viper & Viper Plus Recliner (top mount)	Detach Arm	Push To Lock	\$14.10 ea.
	Q	151-158-SD	Cirrus III (side mount)	Flip Back Arm	Push To Lock	\$15.60 ea.
	R	151-160-SD	Cougar (side mount)	Detach Arm	Push To Lock	\$17.76 ea.
	S	151-162-SD	Silver Sport Recliners (side mount)	Detach Arm	Push To Lock	\$19.52 ea.
	T	151-164-SD	Blue Streak	Detach Arm	Push To Lock	\$15.00 ea.